

selec TS2M1-1-16A-230V / TS1W1-1-20A-230V
Operating Instructions

OP654-V02



SPECIFICATIONS

SUPPLY	
Voltage	230V AC ± 10%
Frequency	50-60Hz
Power Consumption	Approx. 9 Watts at 252 VAC
Battery Backup (Replaceable by user)	TS2M1-1-16A-230V : 10 years TS1W1-1-20A-230V : 10 years
RELAY OUTPUT	
Type of contact	TS2M1-1-16A-230V : 1C/O (SPDT) TS1W1-1-20A-230V : 1NO & Neutral
Contact rating (resistive load)	TS2M1-1-16A-230V : 16A (NO) & 16A (NC) @ 250V AC TS1W1-1-20A-230V : 20A (NO) @ 250V AC
Contact material	AgSnO ₂
Max. Switching Current	TS2M1-1-16A-230V : 16A TS1W1-1-20A-230V : 20A
Electrical life	TS2M1-1-16A-230V : 5x10 ⁶ Operations TS1W1-1-20A-230V : 1x10 ⁷ Operations
Mechanical life	1x10 ⁷ Operations
FUNCTIONAL	
Operation Period	1 week
Weekly Program	Total 50 ON Steps and 50 OFF Steps 2 Programs x 25 steps 3 Programs x 16 steps 4 Programs x 12 steps 5 Programs x 10 steps 6 Programs x 08 steps 7 Programs x 07 steps 8 Programs x 06 steps
Display	Text LCD (Without Backlight)
Character Height	5.07mm(HH:MM) & 3.39mm(SS)
Minimum setting unit	1 second
Holiday Settings	16 Dates max.
Clock	12-hr(AM/PM) and 24-hr selection
Keys	5 Keys with 1 recessed reset button
Relay Operating Mode	Auto / Permanent Override ON / Permanent Override OFF
RTC accuracy	15 mins a year @ 25°C

ENVIRONMENTAL	
Temperature Range	Operating : 0° to 50°C
	Storage : -20° to 70°C
Humidity	10% to 95% RH
Protection class	II
MECHANICAL : TS2M1-1-16A-230V	
Mounting	Din Rail
Type of connection	Terminal screw-16A rating
No of Terminals	5 (L, N, NO, COM, NC)
Dimensions	60mm x 35mm x 90mm
Type of protection	IP20
Weight	105 g
MECHANICAL : TS1W1-1-20A-230V	
Mounting	Wall Mount
Type of connection	Pin Type - 20A rating
No of Terminals	4 (LOAD, NEUT, LINE, NEUT)
Dimensions	60mm x 60mm x 48.50mm
Type of protection	IP20
Weight	100 g

ORDER CODE INFORMATION		
Product	Certification	
TS2M1-1-16A-230V	CE	cULUS LISTED
TS1W1-1-20A-230V	—	—
TS2M1-1-16A-230V-CE	✓	—
TS1W1-1-20A-230V-CE	✓	—

SAFETY PRECAUTIONS

All safety related codifications, symbols and instructions that appear in this operating manual or on the equipment must be strictly followed To ensure the safety of the operating personnel as well as the instrument.

If the equipment is not used in manner specified by the manufacturer it might impair the protection provided by the equipment. If there is physical damage to the unit then do not use it.

Read complete instructions prior to installation and operation of the unit.

The timer functions and set program are backed up by a battery. If the life of the battery expires, the display will become irregular or may fail to function. The battery can be replaced by the user. Contact your SELEC representative before doing so.

Serious injury may occasionally occur due to fire or explosion of a battery, or leakage from a battery. Never attempt to short the positive and negative terminals, recharge, disassemble, deform by applying excessive pressure, or expose the battery to fire.

CAUTION :
1. This equipment, being built-in-type, normally becomes a part of main control panel and in such case the terminals do not remain accessible to the end user after installation and internal wiring.

2. Conductors must not come in contact with the internal Circuitry of the equipment or else it may lead to a safety hazard that may in turn endanger life or cause electrical shock to the operator.
3. Circuit breaker or mains switch must be installed between power source and supply terminals to facilitate power 'ON' or 'OFF' function. However this switch or breaker must be installed in a convenient position normally accessible to the operator.
4. Inductive loads should be equipped with interference suppressors like varistors, RC snubbers.
5. Use of contactors is recommended if load exceeds the contact rating.

WARNING :

1. To prevent risk of electric shock power supply to the equipment must be kept OFF while doing to the wiring arrangement. Use lugged terminals to Meet M3 screws.
2. Wiring shall be done strictly according to the terminal layout with shortest connections. Conform that all connections are correct.
3. To eliminate electromagnetic interference use of short wire with adequate ratings and twists of the same in equal size shall be made.

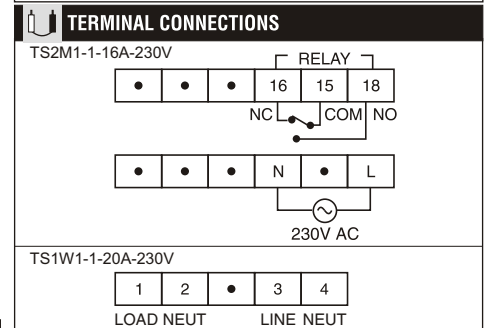
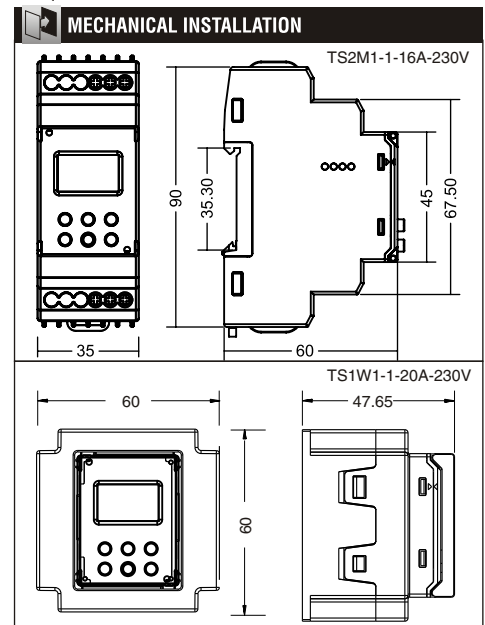

OPERATION FUNCTIONS	
FUNCTION	DESCRIPTION
Adjusting Clock	Allows current date & time settings through day, hrs (24-hr indication and 12-hr indication), minutes, seconds settings
Weekly Timer Operation	Controls the output according to the set time of ON and OFF for specified days of the week
Holiday setting	Sets holidays without having to revise the existing program. Can be set 0 to 16 dates max.
Permanent Override ON / Permanent Override OFF	Allows the output to be forcibly turned ON/OFF regardless of the control output setting.
Keypad Lock	Allows each key to lock / unlock. When key is locked programming parameters of that key cannot be edited.
Programmable No of steps	Allows to modify No of steps per program (Minimum Value = 6, Maximum Value = 25)
Enable / Disable program	Allows to enable / disable particular program

FRONT PANEL DESCRIPTION

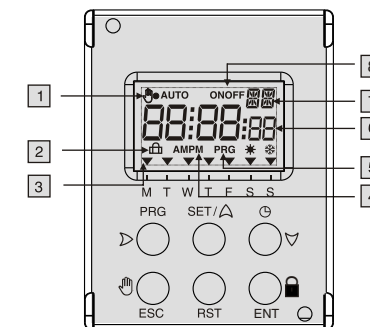

1	Auto : Automatic mode
	☞ : Permanent override
2	Holiday
3	Day of Week indication
4	AM/PM Indication
5	PRG Mode indication (when in programming mode only)
6	Hours/minutes/seconds indication (HH:MM:SS)
7	LB → Lock All & Battery mode L → Lock All & Auxiliary mode B → Unlock All & Battery mode
8	Relay ON/OFF indication

SETTING THE TS2M1-1-16A-230V/TS1W1-1-20A-230V PARAMETER

Note: To change parameters value use "▷/◁/▽": To set value use "ENT": To come out of programming use "ESC" (NOTE 1, 3 & 5)

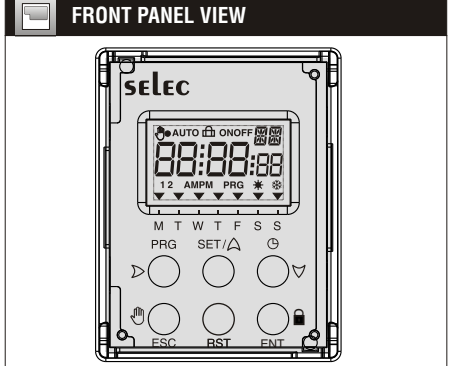
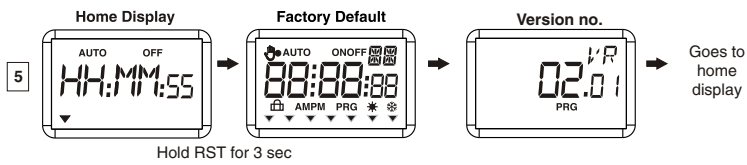
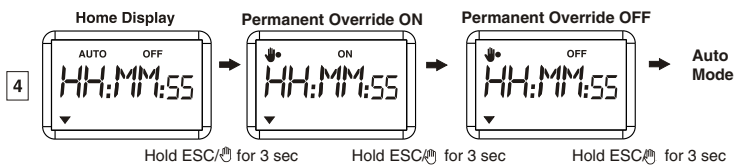
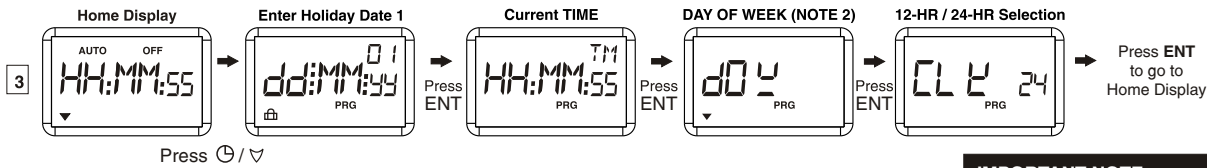
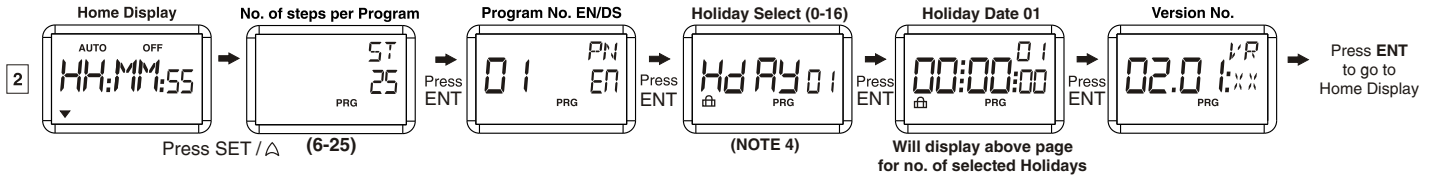
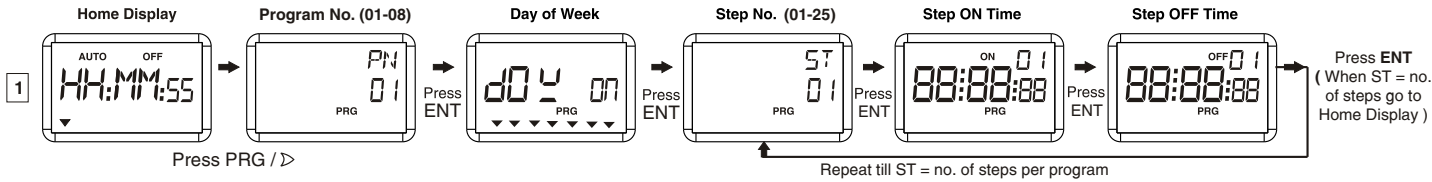

KEY OPERATIONS

To Enter Programming	Press key
Set Control programs and Steps	PRG / ▷
Set Clock – Current Date & Time	⌚ / ▽
Set System Settings	SET / △
Factory Default	RST
To Exit programming	
Run Mode	Press & hold key for 3 secs
Mode Select- switch mode between a) Auto b) Permanent Override ON c) Permanent Override OFF	⌚ / ESC
To Modify Parameter in Programming (PRG) Mode	Press key
NOTE 1 : To modify parametric values.	◁ / ▷ / △ / ▽
NOTE 2 : To Modify Day of Week.	◁ / ▷ - Select Day of Week. △ / ▽ - Toggle On / Off.
NOTE 3 : To confirm selection / programming.	ENT Key
NOTE 4 : To select Holiday dates	△ / ▽ - Select no. of holidays Press ENT to go to Holiday date select (Note1 to edit)
NOTE 5 : Program Out	ESC Key or automatic 60sec program out on key inactivity.

IMPORTANT NOTE

Select no. of Holidays on Holiday select page & then Holiday date enter page will appear for selected no. of Holidays only. If 0 no. of holidays are selected then Holiday date enter page will not appear.

SPECIAL CONDITIONS

- CONDITION 1 :-** Activate Step OFF ON next day :
Set OFF time < ON time applicable only if OFF to be done within 24hrs.
 - CONDITION 2 :-** Activate Step OFF after 2 days :
- A) Apply condition 1
B) Enable multiple programs with overlap time.

ERROR NOTIFICATIONS

Below errors occur at second's place on Home Display when wrong value is entered

Err	Type	Valid Range
E1	Month Out of Range Error	01 to 12
E2	Date Out of Range Error	01 to 31
E3	Hour Out of Range Error	00 to 23
E4	Step Hour Out of Range Error	00 to 23

(Specifications are subject to change, since development is a continuous process.)

Selec Controls Pvt. Ltd., India
Factory Address : EL-27/1, Electronic Zone, TTC Industrial Area, MIDC, Mahape, Navi Mumbai - 400 710, INDIA.
 Tel. No. : +91-22-41 418 468/452 | Fax No. : +91-22-28471733 | Toll free: 1800 227 353 (BSNL/MTNL Subscribers only)
 Website : www.selec.com | Email : sales@selec.com