

SELEC

SMRD4M1-2-U-CE
Operating Instructions



70 x 90 mm
DIN RAIL

SPECIFICATIONS

Display	4 (Red) digits, 0.43" height, 7 seg LED LED's : 2(Red)
No. of keys	3
Supply Voltage	90 to 270 VAC, 50/60Hz
Sensor Supply	12VDC, 30mA (±10%) (Short circuit protected)
Rate Range	Auto ranging. RPS, RPM or RPH mode user selectable
Set Points	High set-point and low set-point each programmable from 1 to 9999
Operating modes	Under-speed, Over-speed and Dual-speed
Error	10% of actual reading
Count Inputs	5 to 30VDC from proximity switches, encoders, solid state devices, potential free contacts* like limit switches, relays
Scale Factor	Programmable from 0.001 to 9.999 x 10n Where n = -3, -2, -1, 0, 1, 2
Relay Output	2 relays, 1C/O each rated 5 A @ 230 VAC / 24 VDC
Memory Retention	10 years
Type of Protection	IP20 on terminal
Input Speed Range	0.06 RPS to 166RPS

ENVIRONMENTAL CONDITIONS

Temperature	Operating : 0 to 55°C, Storage : -20 to 75°C.
Humidity	95% RH
Mounting	Din Rail Mounted
Weight	193 grams

*When using potential free contacts, it is recommended to utilize the +12V sensor supply provided in the unit..

WIRING DIAGRAM FOR COUNT INPUT

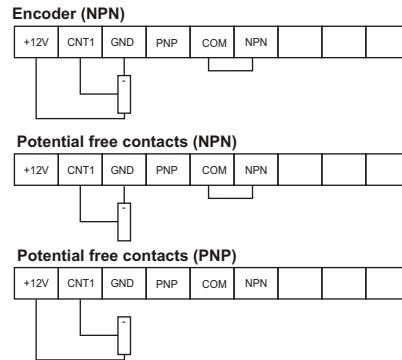

NOTE :

1. If the sensors (Proximity / Encoder) require more than 30mA current, use external power supply to power the sensors.
2. For PNP type sensors, PNP-COM shorting is not required. The unit operates in PNP mode by default.
3. For NPN type sensors, NPN-COM should be short as shown in the below diagram.

TERMINAL CONNECTIONS

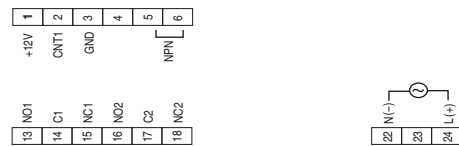

MECHANICAL INSTALLATION

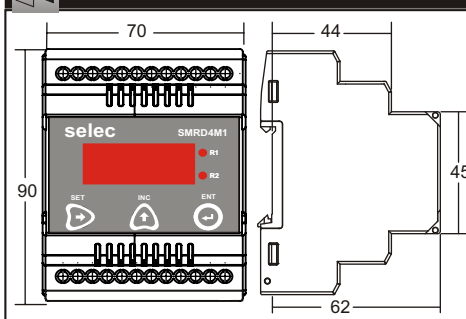

Key Functions in Brief

To view programmed modes

- Key** : Press once to view operating mode and rate
- Key** : Press once to de-energize relays in manual mode.

To enter Configuration settings:

- Key** : Press for 3sec to enter/ exit configuration mode OR to enter next configuration.
- Key** : Increments the blinking digit after every key press and rolls over from 0 to 9
- Key** : Shifts the blinking to next digit for every key press

CONFIGURATION SCHEME (Parameter setting)

Press the ENT () key for 3 seconds to enter/ exit the configuration settings.

Configuration Parameter	Display	Description
Initial Time Delay	*Blinking for 3 seconds 1t d	Key : To go to next page before 3 seconds is complete
	000	Key : Increments the blinking digit after every key. press and rolls over from 0 to 9 Key : Shift the blinking to next digit (right) for every key press
Nuisance Time Delay	*Blinking for 3 seconds nt d	Key : To go to next page before 3 seconds is complete
	000	Key : Increments the blinking digit after every key. press and rolls over from 0 to 9 Key : Shift the blinking to next digit (right) for every key press
Operating Mode	*Blinking for 3 seconds nODE	Key : To go to next page before 3 seconds is complete
	DUAL	Key : Changes mode of operating Range : Dual, Under, Over
Rate Mode	*Blinking for 3 seconds rAtE	Key : To go to next page before 3 seconds is complete
	rPn	Key : Changes factor of rate Range : RPM, RPS, RPH Default : RPM
Relay Reset Mode	*Blinking for 3 seconds rSt	Key : To go to next page before 3 seconds is complete
	AUTO	Key : Changes relay reset mode Range : Auto, Manual Default : Auto
Scale Factor Mantissa	*Blinking for 3 seconds 5CL	Key : To go to next page before 3 seconds is complete
	1.000	Key : Increments the blinking digit after every key press n = -3, -2, -1, 0, 1, 2
Exponent	*Blinking for 3 seconds EPn	Key : To go to next page before 3 seconds is complete
	0	Key : Increments value (0-5). No action from 0-4. Factory reset when ENT is pressed at 5.
Factory reset	*Blinking for 3 seconds FRSt	Key : To go to next page before 3 seconds is complete
	0	Key : Increments value (0-5). No action from 0-4. Factory reset when ENT is pressed at 5.

To program Low Set-point & High Set-point

- Key** : Press for 3 sec. From default page.
- Key** : Increments the blinking digit after every key press and rolls over from 0 to 9 (-,0,1,...,9 for 1st digit)
- Key** : Shifts the blinking to next digit (right) for every key press
- Key** : To enter value/ to go to next configuration. Press for 3 seconds to exit programming mode.

Configuration Parameter	Display	Description
Set-Point Low/ High	Blinking for 3 seconds LOy	Key : To go to next page before 3 seconds is complete
	0100	Key : Increments value blinking digit

Modes of Operation:

i) **Dual-speed Mode:** The relay checks whether the speed of the monitored system is within a particular range, defined as Set-Point Low to Set-Point High. R2 is energized when the frequency of rotation becomes lower than Set-point Low. R1 is energized when the frequency of rotation becomes greater than Set-point High.

ii) **Under-speed Mode:** The relay checks whether the speed of the monitored system is lower than a particular set-point, defined as Set-Poin Low. R2 is energized when the frequency of rotation becomes lower than Set-Point Low.

iii) **Over-Speed Mode:** The relay checks whether the speed of the monitored system is greater than a particular set-point, defined as Set-Point High. R1 is energized when the frequency of rotation becomes greater than Set-Point High.

Note: Relay 1 has been assigned for Over-speed and Relay 2 has been assigned for Under-speed by default. These cannot be interchanged. **Both the relays are NOT energized when the connected motor is operating within the preset range.**

Initial Time Delay: When monitoring for under-speed conditions, a feature to bypass the time required by the motor to gain optimum speed becomes necessary. When the ITD is entered, the unit waits for the user-entered delay to elapse before switching the relay outputs.

Nuisance Time Delay: Sometimes the motor speed can go out of range for a while. In order to avoid the relays energizing due to such momentary changes in frequency, nuisance time delay is provided. The relay energizes only if unhealthy speed ensues after NTD has elapsed.

Relay reset modes:

This feature allows one to customize the operating of both the relay outputs R1 and R2, according to one's requirement.

Auto-reset: The relay outputs R1 and R2 become deenergized when the speed of the connected equipment comes back to the prescribed range.

Manual-reset: Once the relay outputs R1 and/ or R2 become energized, they stay energized even after the connected motor or any supported equipment comes back to healthy speed. In order to de-energize the relays, the user will have to press the assigned key.

SCALE FACTOR

The user programmable scale factor facilitates the direct reading in desired engineering unit.

The counter multiplies the number of pulses received at the count input with the scale factor, and displays the result.
Rate display = Number of pulses received per minute x scale factor or No. of pulses received per hour x scale factor.

The scale factor consists of two parts, mantissa and exponent. The mantissa can be set from 0.001 to 9.999 and the exponent can be set from -3 to +2. The scale factor is arrived at as:

$$\text{Scale factor} = \text{Mantissa} \times 10^{\text{Exponent}}$$

*Set-Point High will only accept values greater than Set-Point Low. Also, both values should be whole.

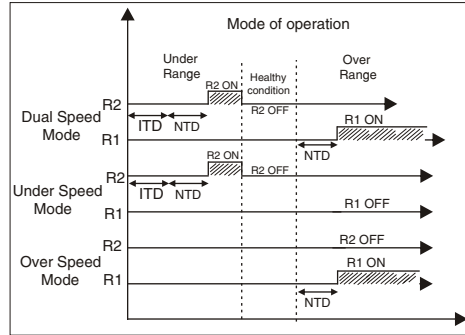

TYPICAL APPLICATION

Objective : To display the delivery rate of the cord (meters / minute).

Data available :

Example 1 :
The proximity switch generates one pulse per revolution of the measuring wheel. The diameter of the measuring wheel is 10 cm.

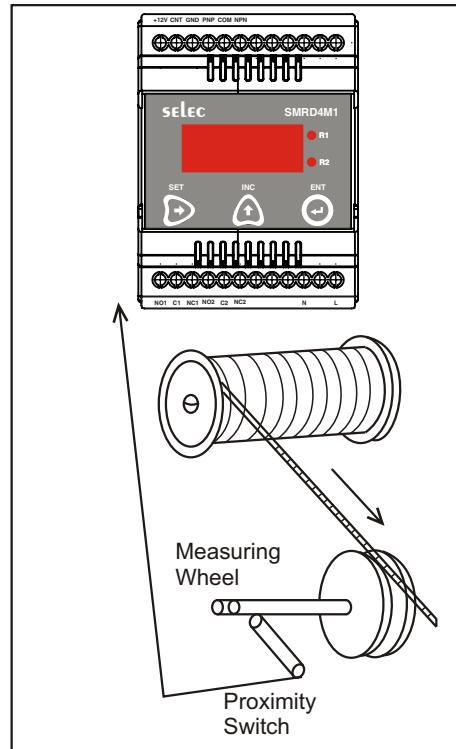

CALCULATIONS

The circumference of the wheel = $3.142857 \times 0.1 = 0.3142857$ meters.
Therefore the length of rope delivered per revolution is 0.3142857 meters.

Since the proximity switch gives one pulse per revolution, the display should increment by 0.3142857 for every pulse.
Therefore, scale factor = 0.3142857
Set scale factor mantissa = 3.14285 & exponent = 10^{-1}

In field applications, more than one metal probes can be used around a single motor. Consider that two such metals are used in the above example. Now, the proximity switch will give one pulse per half a revolution. Thus, the scale factor should be 0.5 . i.e., Mantissa = 5.000 and Exponent = 10^{-1} . In effect the rate needs to be divided appropriately to take into account the addition of each metal probe. The SMRD4M1 will show rate in meters / minute.

EXAMPLE 2 :

In above application if 60 PPR encoder is fitted instead of proximity.

Therefore
a) The length of rope delivered per revolution is 0.3142857 meters
b) The number of pulses per revolution = 60
c) Length of rope delivered per count pulse = $0.3142857 / 60 = 0.005238$ meter.
The display should increment by 0.005238 for every pulse. therefore, scale factor = 5.23800×10^{-3}
Set scale factor mantissa = 5.23800 & exponent = 10^{-3} for required display.

SAFETY PRECAUTIONS

This manual is meant for personnel involved in wiring, installation, operation and routine maintenance of the equipment. All safety related conditions, symbols and instructions that appear in this operating manual or on the equipment must be strictly followed to ensure operator and instrument safety. Any misuse may impair the protection provided by the equipment.

CAUTION : Read complete instructions prior to installation and operation of the unit.
CAUTION : Risk of electric shock.

1. This equipment, being built-in-type, normally becomes a part of the main control panel and the terminals do not remain accessible to the user after installation.
2. Conductors must not come in contact with the internal circuitry of the equipment else it may lead to a safety hazard that may endanger life or cause electrical shock to the operator.
3. Circuit breaker or mains switch must be installed between the power source and supply terminals to facilitate power 'ON' or 'OFF' function.
4. The equipment shall not be installed in environmental conditions other than those specified in this manual.
5. Since this equipment forms part of the main control panel, its output terminals get connected to the host equipment. Such equipment shall also comply to EMI / EMC and safety requirements like CE standard procedure.
7. Thermal dissipation of equipment is met through ventilation holes provided on housing of equipment. Obstruction of these ventilation holes may lead to a safety hazard.
8. The output terminals shall be loaded strictly as per the values / range specified by the manufacturer.

ELECTRICAL PRECAUTIONS DURING USE

Electrical noise generated by switching of inductive loads can create momentary disruption, erratic display, latch up, data loss or permanent damage to the instrument.

TYPICAL CONNECTIONS FOR LOADS

For load current < than 0.5A

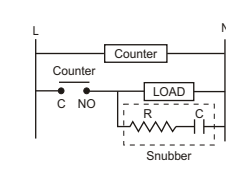

For higher loads use interposing relay / contactor

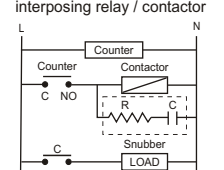

NOTE : a) Use snubber as shown above to increase life of internal relay
b) Use separate shielded wires for inputs.

CAUTION

The equipment in its installed state must not come in close proximity to any heating sources, caustic vapors, Oils, steam, or other unwanted process by products.

EMC Guidelines :

1. Use proper input power cables with shortest connections and twisted type.
2. Layout of connecting cables shall be away from any internal EMI source.

NOTE : Below mentioned diagram is applicable only for 230V relay outputs.

(Specifications are subject to change, since development is a continuous process.)

Selec Controls Pvt. Ltd., India

Factory Address :

EL-27/1, Electronic Zone, TTC Industrial Area, MIDC, Mahape, Navi Mumbai - 400 710, INDIA.

Tel. No. : +91-22-41 418 419/430 |

Fax No. : +91-22-28471733

Toll free : 1800 227 353 (BSNL/MTNL Subscribers only)

Website : www.selec.com | Email : sales@selec.com