



FEATURES

- Earth leakage current monitoring in 1Ø and 3Ø systems
- RMS value measurement(AC)
- User selectable trip time delay, leakage current levels
- CBCT detection
- 'Test' and 'Reset' via front/remote
- One SPDT relay output

SPECIFICATIONS

ELECTRICAL CONNECTION

3Ø - 3 wire or 3Ø - 4 wire or 1Ø - 2 wire

AUXILLIARY SUPPLY

230V AC (±15%), 50 / 60Hz

OPERATING RANGE

30, 100, 300, 500mA and
1, 3, 5, 10, 20, 30A

POWER CONSUMPTION

5VA max

TRIP LEVEL LIMITS

95% to 105% of set value

TIME SETTINGS

Trip Time Delay

0,0.15, 0.25, 0.5, 1, 2, 3, 5, 7.5, 9 sec
(NA when leakage less than 30mA)

Reset Time

~1 sec.

Response Time

< 30ms (if trip current ≥ 5 X set value)
< 50ms (if trip current = 1 X set value)

RESET ENABLE LEVEL

Below 85% of trip level and in presence of CBCT

CBCT DETECTION

Yes, when CBCT absent or short

ACCURACY

Trip : ± 5 % of Set Trip Current
Time : ± 5 % of Set Time ± 50ms

TEST/RESET FACILITY

1. Front panel
2. Remote (through terminal contact)

OUTPUT SPECIFICATION

1. Relay : 1 C/O(SPDT)

RELAY RATING

Case 1: 10A@277V AC/28DC⁽¹⁾(NO)

Case 2: 5A@250V AC(NO),
5A@250V AC(NC)

Note: 1) Applicable when NC is not energized with load

LED INDICATION

1. **YELLOW** : Power ON indication
2. **RED** : Trip indication
3. **Green LEDs (blinking)** :
CBCT error / CBCT absent / CBCT short
4. **Green LEDs ON**:
showing leakage current condition
(25%, 50% and 75%)

ENVIRONMENTAL SPECIFICATIONS

- Indoor use
- Altitude of upto 2000meters
- Pollution Degree 2
- Temperature : Operating : 0 to 50 °C
Storage : 0 to 75 °C
- Humidity : Upto 95% RH (Non-condensing)

DEGREE OF PROTECTION

IP20 For terminal
IP40 For housing
IP50 For faceplate

MECHANICAL SPECIFICATIONS

- Dimension : 35 x 90 x 60
- Mounting : 35mm Din rail mounting
- Wire size(max) : 4sq. mm. Rated
- Screw tightening torque : 0.5 N.m

WEIGHT

ELRA2M2-1-230V-CE-RoHS : 157gms

SAFETY PRECAUTIONS

All safety related codifications, symbols and instructions that appear in this operating manual or on the equipment must be strictly followed to ensure the safety of the operating personnel as well as the instrument.

If the equipment is not used in a manner specified by the manufacturer it might impair the protection provided by the equipment.

Read complete instructions prior to installation and operation of the unit.

WIRING GUIDELINES

WARNING

1. To prevent the risk of electric shock power supply to the equipment must be kept OFF while doing the wiring arrangement.
2. Wiring shall be done strictly according to the terminal layout with shortest connections. Confirm that all connections are correct.

CAUTION

1. To ensure the safe operation of unit, check the wiring and connections.
2. It is recommended to test the unit periodically to satisfy the regulations.

MECHANICAL INSTALLATION

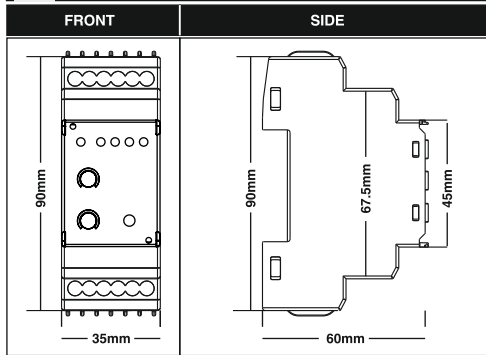

LED BARGRAPH

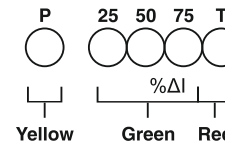

NOTE FOR CONNECTION

For single phase applications, only the live and neutral needs to be passed through the CBCT. The Earth **MUST NOT** pass through the CBCT. The distance between relay and CBCT should be kept as short as possible. Use screen, shielded cable or twisted pair cable between the unit and CBCT for long distance (Greater than 1m).

TERMINAL CONNECTIONS

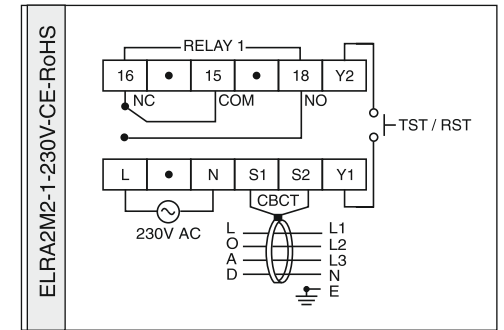

CORE BALANCED CURRENT TRANSFORMER

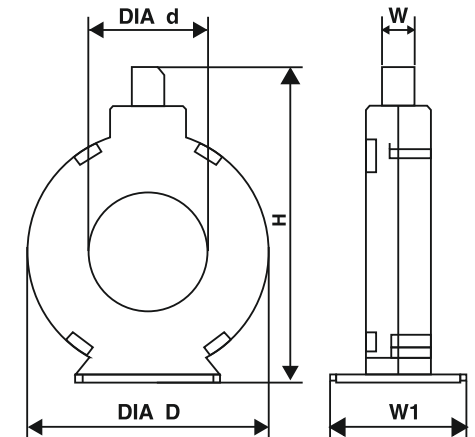

CBCT TYPE	Dimensions (mm)				
	D	d	H	W	W1
35-1	70	35	97	15	40
70-1	106	70	133	15	40
120-1	157	120	185	15	40
210-1	266	210	270	25	55
310-1	375	310	380	25	65
STD. TOL.	2 - 3	5 - 6	-	1.5 - 2	-



CT Type ZPC (Zero Phase Current)

MODES OF OPERATION

- 1) Turn power ON
- 2) The yellow “supply ON” LED will illuminate and all other LEDs flash for a while.

1. Test mode

The unit can be placed into a fault condition by pressing the “TST / RST” button on the front of the unit (or by shorting terminals Y1 &

Key press	Display	Description
TST/RST Press 	P 25 50 75 T  %Δi	In test mode, all LEDs illuminate & trip relay energises, indicating proper operation of unit.

2. Normal Operating mode

Current range is set using knob of indication Δi (A)

Key press	Display	Description
NONE	P 25 50 75 T  %Δi	For eg. If Δi (A) =10Amp & Leakage current=2.5Amp then LED '25' (green) glows



- A. For leakage current level < 25% - All bargraph LED's off
 - B. For leakage current level > = 25% - LED '25' glows
 - C. For leakage current level > = 50% - LED '25' & '50' both glows
 - D. For leakage current level > = 75% - LED '25', '50' & '75' glows
 - E. For leakage current level 95 to 105% - All LEDs glow after set trip time is over
- Protection relay is energised after set time delay is over.

NOTE : At CBCT error condition, red LED and other 3 green LED's are continuously blinking.

3. To reset the unit

Press the 'TST / RST' button on the front of the unit or short terminals Y1 & Y2 to reset the unit.

- NOTE :** 1. Applicable only when unit is in tripped condition and leakage current is less than 85% of tripped level.
2. The “TST/RST” button does not work in the absence of CBCT.

Key press	Display	Description
TST/RST Press 	P 25 50 75 T  %Δi	All LED's are switched off indicating output relay's “non tripped state”

USER GUIDE

Significance of the Test button :

Test button is used to check the proper functioning of the unit even in the absence of leakage current.

i.e To check the proper functioning of unit when there is no leakage current and CBCT connected to unit press the TST/RST button. On pressing TST/RST button, all LEDs glows and trip relay energises instantly showing that the unit is working properly.

NOTE : At CBCT error condition, red LED and other 3 green LED's are continuously blinking.

Significance of the Reset button :

When there is leakage current above the set value of current unit trips ie all LEDs illuminate. At that time to reset the unit to prior to the fault condition press reset button.

Reset enable level :

When leakage current increases above the set value of current unit trips & all LEDs glows indicating trip of the unit. At that time to reset the unit to previous condition (i.e prior to trip condition), leakage current should be minimize to less than 85% of set value. This value is known as reset enable value at which unit can reset.

Trip relay (Protection relay) :



When leakage current exceeds the set value,
1. Trip relay energises

Trip time delay :

The time taken by unit to trip when fault occurs is called trip time delay.

The time delay should be long enough to avoid nuisance tripping caused by harmless transients, yet fast enough to open the circuit when a hazard exists.

ORDER CODE INFORMATION

Product	Supply	Certification
		 
ELRA2M1-2-230V-CE-RoHS	230V AC (±15%)	 —

WARRANTY / LIMITATIONS OF LIABILITY

Selec warrants the products to be free from defects in the materials and workmanship for a period of one year (or other period specified, if any) from the date of sale by Selec.

The warranty does not apply to defects resulting from any action of the buyer, including but not limited to improper handling, operating the product outside the specification limits or unauthorized disassembling / altering of the product. The warranty shall be VOID if the product shows evidence of having been tampered or being damaged due to usage in corrosive environment ; or current, heat, moisture or vibration ; improper specification ; wrong usage in an application ; misuse or other operating conditions outside of Selec's control.

Selec shall not be responsible for special, indirect or consequential damages, loss of profits or commercial loss in any way connected with the products, whether such claim is based on contract, warranty, negligence or strict liability.

In no event shall the responsibility of Selec for any act exceed the individual price of the product on which liability is asserted.

In no event shall Selec be responsible for warranty or other claims regarding the products unless Selec's analysis confirms that the products were properly handled, stored, installed and maintained and not subject to contamination, abuse, misuse or inappropriate modification or repair.

(Specifications are subject to change, since development is a continuous process.)

Selec Controls Pvt. Ltd., India

Factory Address :
EL-27/1, Electronic Zone, TTC Industrial Area, MIDC, Mahape,
Navi Mumbai - 400 710, INDIA.
Tel. No. : +91-22-41 418 419/430 | Fax No. : +91-22-28471733
Toll free : 1800 227 353 (BSNL/MTNL Subscribers only)
Website : www.selec.com | Email : sales@selec.com