

selec

TC513A / TC513AX / TC221A /
TC203AX / TC303A / TC303AX
Operating Instructions



SPECIFICATIONS

- Display**
3 digit, 7 segment digital display
- LED Indications**
R : Control output ON
- Keys**
3 keys for digital setting
- INPUT SPECIFICATIONS**
- Input Signal**
Thermocouple (J,K,T,R,S) / RTD (Pt100)
- Sampling time**
250ms
- Input Filter (FTC)**
0.2 to 10.0 sec
- Resolution**
Fixed 1° resolution
- Temperature Unit**
°C / °F selectable
- Indication Accuracy**
For TC inputs: 0.25% of FS ±1°
For R & S inputs: 0.5% of F.S ±2°
(20 min of warm up time for TC input)
For RTD inputs: 0.1% of FS ±1°

FUNCTIONAL SPECIFICATIONS

- Control Method**
1) PID control with auto tuning
2) ON-OFF control
- Proportional Band (P)**
1 to 400°
- Integral Time (I)**
0.0 to 99.9 min
- Derivative Time (D)**
0 to 999 sec
- Cycle Time**
0.1 to 99.9 sec
- Hysteresis Width**
0.1 to 99.9°
- Manual Reset Value**
-19.9 to 19.9°

CONTROL OUTPUT : Relay or SSR

- (One Output at a time)
- Relay contact (SPST)** (For TC513A,TC221A,TC303A)
10A@250V AC / 30V DC, resistive
- Relay contact (SPDT)** *(For TC513AX, TC203AX, TC303AX)
10A@250V AC / 30V DC, resistive
- SSR Drive Output (Voltage Pulse)** *
12V DC, 50 mA

* Not applicable for TC513A,TC221A,TC303A

POWER SUPPLY

- Supply Voltage**
85 to 270V AC/DC (AC : 50 or 60Hz)
OPTIONAL - 24V AC/DC
- Power Consumption**
5VA max @230V AC
- Temperature**
Operating : 0 to 50°C ; Storage : -20 to 75°C
- Humidity (non-condensing)**
95% RH
- Weight**
TC513A/TC513AX : 129 gms
TC221A/TC203AX : 180 gms
TC303A/TC303AX : 240 gms

SAFETY PRECAUTIONS

All safety related codifications, symbols and instructions that appear in this operating manual or on the equipment must be strictly followed to ensure the safety of the operating personnel as well as the instrument.
If the equipment is not handled in a manner specified by the manufacturer it might impair the protection provided by the equipment.

Read complete instructions prior to installation and operation of the unit.

WARNING : Risk of electric shock.

WIRING GUIDELINES

- WARNING :**
- To prevent the risk of electric shock power supply to the equipment must be kept OFF while doing the wiring arrangement. Do not touch the terminals while power is being supplied.
- To eliminate electromagnetic interference use short wire with adequate ratings ; twists of the same in equal size shall be made. For the input and output signal lines, be sure to use shielded wires and keep them away from each other.
- Cable used for connection to power source, must have a cross section of 1mm² or greater. These wires shall have insulation capacity made of at least 1.5kV.
- When extending the thermocouple lead wires, always use thermocouple compensation wires for wiring. For the RTD type, use a wiring material with a small lead resistance (5Ω max per line) and no resistance differentials among three wires.
- A better anti-noise effect can be expected by using standard power supply cable for the instrument.

MAINTENANCE

- The equipment should be cleaned regularly to avoid blockage of ventilating parts.
- Clean the equipment with a clean soft cloth. Do not use Isopropyl alcohol or any other cleaning agent.

INSTALLATION GUIDELINES

- This equipment, being built-in-type, normally becomes a part of main control panel and in such case the terminals do not remain accessible to the end user after installation and internal wiring.
- Do not allow pieces of metal, wire clippings, or fine metallic fillings from installation to enter the product or else it may lead to a safety hazard that may in turn endanger life or cause electrical shock to the operator.

- Circuit breaker or mains switch must be installed between power source and supply terminals to facilitate power 'ON' or 'OFF' function. However this switch or breaker must be installed in a convenient position normally accessible to the operator.
- Use and store the temperature controller within the specified ambient temperature and humidity ranges as mentioned in this manual.

CAUTION

- When powering up for the first time, disconnect the output connections.
- Fuse Protection : The unit is normally supplied without a power switch and fuses. Make wiring so that the fuse is placed between the mains power supply switch and the controller. (2 pole breaker fuse- rating : 275V AC,1A for electrical circuitry is highly recommended)
- Since this is a built-in-type equipment (finds place in main control panel), its output terminals get connected to host equipment. Such equipment shall also comply with basic EMI/EMC and other safety requirements like BSEN61326-1 and BSEN61010 respectively.
- Thermal dissipation of equipment is met through ventilation holes provided on chassis of equipment. Such ventilation holes shall not be obstructed else it can lead to a safety hazard.
- The output terminals shall be strictly loaded to the manufacturer specified values/range.

MECHANICAL INSTALLATION

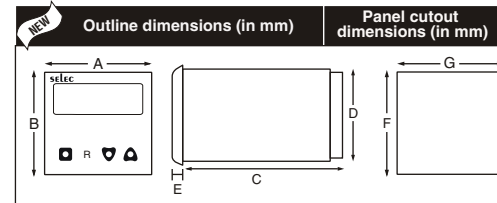

| DIM | A | B | C | D | E | F | G |
|----------------|----|----|------|------|-----|----|----|
| TC513A/TC513AX | 52 | 52 | 94 | 45 | 4 | 46 | 46 |
| TC221A/TC203AX | 72 | 72 | 83.7 | 67 | 4.5 | 69 | 69 |
| TC303A/TC303AX | 96 | 96 | 73 | 90.5 | 5 | 92 | 92 |

- Prepare the panel cutout with proper dimensions as shown above.
- Remove the clamp from the controller and push the controller into the panel cutout. Insert the clamp from the rear side until the main unit is securely fit into the panel.
- The equipment in its installed state must not come in close proximity to any heating sources, caustic vapors, oils, steam, or other unwanted process by-products.
- Use the specified size of crimp terminals (M3.5 screws) to wire the terminal block. Tighten the screws on the terminal block using the tightening torque within the range of 1.2 N.m.
- Do not connect anything to unused terminals.

EMC Guidelines :

- Use proper input power cables with shortest connections and twisted type.
- Layout of connecting cables shall be away from any internal EMI source.

LOAD CONNECTIONS

- The service life of the output relays depends on the switching capacity and switching conditions. Consider the actual application conditions and use the product within the rated load and electrical service life.
- Although the relay output is rated at 10 amps it is always necessary to use an interposing relay or contactor that will switch the load. This avoids damage to the controller in the event of a fault short developing on the power output circuit.
- Always use a separate fused supply for the "power load circuit" and do not take this from the live and neutral terminals supplying power to the controller.

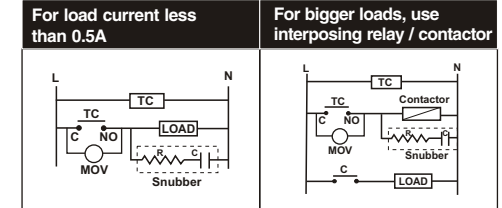

ELECTRICAL PRECAUTIONS DURING USE

Electrical noise generated by switching of inductive loads can create momentary disruption, erratic display, latch up, data loss or permanent damage to the instrument.

- To reduce noise :**
- a) Use of snubber circuits across loads as shown above, is recommended.
- b) Use separate shielded wires for inputs.

TERMINAL CONNECTIONS

*NC contact valid only for TC513AX

| Control Output | |
|--|--|
| Relay Output | SSR Drive Output |
| | |
| Measured Value Input | |
| Thermocouple (J, K, T, R, S) | RTD (Pt100) |
| | |
| Connect thermocouple sensor according to polarity shown. | For 2-wire RTD input short terminals 7 and 8 |

For TC513A/TC513AX

TERMINAL CONNECTIONS

For TC221A/TC203AX

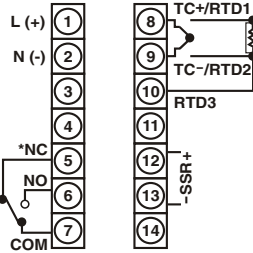

*NC contact valid only for TC203AX

Control Output

Relay Output

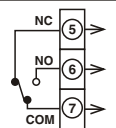

SSR Drive Output

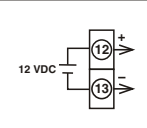

Measured Value Input

Thermocouple (J, K, T, R, S)

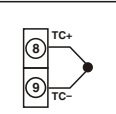

Connect thermocouple sensor according to polarity shown.

RTD (Pt100)

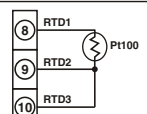

For 2-wire RTD input short terminals 9 and 10.

For TC303A/TC303AX

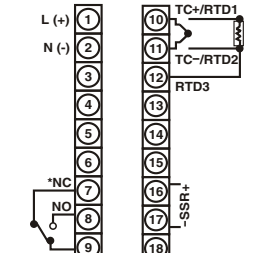

*NC contact valid only for TC303AX

Control Output

Relay Output

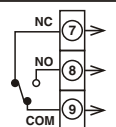

SSR Drive Output

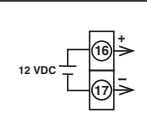

Measured Value Input

Thermocouple (J, K, T, R, S)

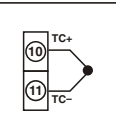

Connect thermocouple sensor according to polarity shown.

RTD (Pt100)

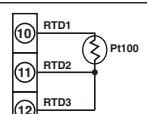

For 2-wire RTD input short terminals 11 and 12

WARNING: Please check the power supply voltage and controllers output type ordered (with reference to the order code) before installation.

Use only the correct thermocouple wire or compensating cable from the probe to instrument terminals avoiding joints in the cable if possible. Failure to use the correct wire type will lead to inaccurate readings.

Ensure that the input sensor connected at the terminals and the input type set in the temperature controller configuration are the same.

FRONT PANEL DESCRIPTION

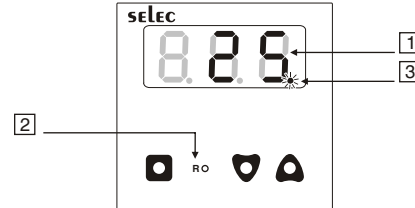

| | | |
|---|---|---|
| 1 | Process-value (PV) / Parameter name display | 1) Displays a process value (PV). 2) Displays the parameter symbols at parameter setting mode for 1 sec and then parameter values. 3) Displays PV error conditions. (refer Table 2) |
| 2 | Control output indication | 4) Displays a set value (SV) when key pressed. The LED is lite when the control output is ON |
| 3 | Tune | Auto tune: Decimal point blinks with faster speed. |

FRONT KEYS DESCRIPTION

| Functions | Key press |
|--|--|
| Online | |
| To view Level 1 | Press key for 3 seconds. |
| To view Level 2 | Press key for 3 seconds. |
| To view Protection Level | Press + keys for 3 seconds. |
| To view and change set point value | Press to view the set point. Press + / key to change the set point. |
| Programming Mode | |
| To view parameters on the same level. | or key once to view the next or previous function in operational menu. |
| To increase or decrease the value of a particular parameter. | + to increase and + to decrease the function value. Note: Parameter value will not alter when respective level is locked. |
| NOTE: The unit will auto exit programming mode after 30 seconds of inactivity. | |
| OR By pressing the or + keys for 3 seconds. | |

USER GUIDE

1. Display Bias:

This function is used to adjust the PV value in cases where it is necessary for PV value to agree with another recorder or indicator, or when the sensor cannot be mounted in correct location.

2. Filter Time Constant

The input filter is used to filter out quick changes that occur to the process variable in a dynamic or quick responding application which causes erratic control. The digital filter also aids in controlling processes where the electrical noise affects the input signal. Larger the value of FTC entered, greater the filter added and the slower the controller reacts to the process and vice versa.

3. Auto tuning:

The Auto-tuning function automatically computes and sets the proportional band (P), integral time (I), Derivative time (D), ARW% and cycle time (CY.T) as per process characteristics.

- Decimal point of LSD flashes at faster speed while auto-tuning is being performed.
- At the completion of Auto-tuning, the decimal point stops blinking.

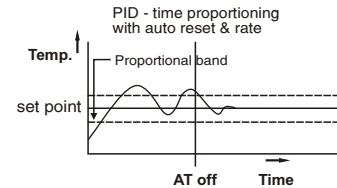

- If the power goes OFF before auto-tuning is completed, auto-tuning will be restarted at next power ON.
- If auto-tuning is not completed after 3-4 cycles, the auto-tuning is suspected to fail. In this case, check the wiring & parameters such as the control action, input type, etc.
- Carry out the auto-tuning again, if there is a change in setpoint or process parameters.

4. ON/OFF control action (For Reverse Mode):

The relay is 'ON' up to the set temperature and cuts 'OFF' above the set temperature. As the temperature of the system drops, the relay is switched 'ON' at a temperature slightly lower than the set point.

HYSTERESIS:

The difference between the temperature at which relay switches 'ON' and at which the relay switches 'OFF' is the hysteresis or dead band.

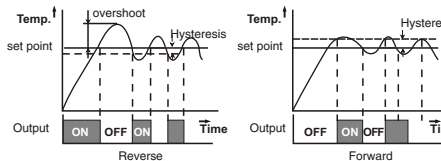

5. Manual Reset (for PID control & I=0):

After some time the process temperature settles at some point and there is a difference between the set temperature & the controlled temperature. This difference can be removed by setting the manual reset value equal & opposite to the offset.

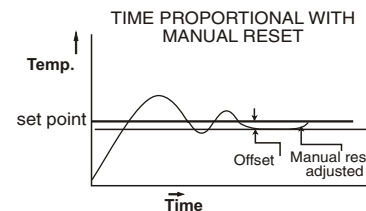

CALIBRATION CERTIFICATE

Date :

Model No :

Claimed Accuracy :

For TC inputs : 0.25% of FS $\pm 1^\circ$
For R & S inputs : 0.5% of F.S $\pm 2^\circ$
(20 min of warm up time for TC input)
For RTD inputs : 0.1% of FS $\pm 1^\circ$

Sources calibrated against :

Multimeter calibration report no :

The calibration of this unit has been verified at the following values :

| SENSOR | CALIBRATION TEMP ($^\circ\text{C}$) | DISPLAY VALUE ($^\circ\text{C}$) |
|--------|---------------------------------------|------------------------------------|
| J | 35 | 35 |
| | 300 | 300 |
| | 600 | 600 |
| K | 35 | 35 |
| | 500 | 500 |
| | 990 | 990 |
| PT100 | 0 | 0 |
| | 400 | 400 |
| | 800 | 800 |

The thermocouple / RTD curves are linearised in this microprocessor based product; and hence the values interpolated between the readings shown above are also equally accurate; at every point in the curve.

Unit is accepted as accuracy is within the specified limit of claimed accuracy and certificate is valid upto one year from the date of issue.

CHECKED BY :

CONFIGURATION INSTRUCTIONS

KEY FUNCTIONS

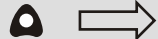

Press for 3 sec to enter Level 2

Press once to view next parameter in configuration menu



Press for 3 sec to enter Level 1

Press once to view previous parameter in configuration menu



Press for 3 sec to enter protection Level



Allows the user to increase or decrease associated parameter value



To exit configuration menu press any of these keys for 3 sec

OPERATIONAL MENU

POWER ON

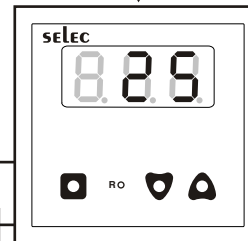

Press key for 3 sec.

Press key for 3 sec.

Press keys for 3 sec.

Level 1

| Display (For 1sec) | Description | Default Value | Range | Display Condition |
|--------------------|---|---------------|--------------------------------------|-------------------|
| INP | Input type (Refer Table 1) | J | J/K/T/R/S/RTD | — |
| UNIT | Temperature unit | °C | °C/°F | — |
| SP.L | Set point low limit | -199 | Min range of sensor selected to SP.H | — |
| SP.H | Set point high limit | 150 | SP.L to Max range of sensor selected | — |
| FIL | Filter time constant (Refer user guide) | 1.0 | 0.2 to 10.0 sec | — |
| ACT | Control action | RE | RE/FD | — |
| LOG | Control logic | PID | PID/ONF | — |
| ARW | Anti reset windup% | 25 | 1 to 100 % | For CNT=PID |
| RS | Factory default (Reset all) | NO | NO/YES | — |

Level 2

| Display (For 1sec) | Description | Default Value | Range | Display Condition |
|--------------------|---------------------------------|---------------|-----------------|-------------------|
| TUNE | Tune (Refer user guide) | OFF | OFF/ON | For CNT=PID |
| P | Proportional band | 10 | 1 to 400° | For CNT=PID |
| I | Integral time | 2.0 | 0.0 to 99.9 min | For CNT=PID |
| D | Derivative time | 3.0 | 0 to 999 sec | For CNT=PID |
| CY.M | Cycle time mode | AUT | AUT/US.F | For CNT=PID |
| CY.T | Cycle time | 15.0 | 0.1 to 99.9 sec | For CNT=PID |
| HYS | Hysteresis | 1.0 | 0.1 to 99.9° | For CNT=ONF |
| MAN | Manual reset (Refer user guide) | 0.0 | -19.9 to 19.9° | For CNT=PID & I=0 |
| DB | Display bias (Refer user guide) | 0.0 | -19.9 to 19.9° | — |

Protection Level

| Display (For 1sec) | Description | Default Value | Range | Display Condition |
|--------------------|---------------|---------------|---------|-------------------|
| SP | Lock setpoint | UNL | UNK/LCK | — |
| LV1 | Lock Level 1 | UNL | UNK/LCK | — |
| LV2 | Lock Level 2 | UNL | UNK/LCK | — |

Note

- Locking parameters (LV1 or LV2 or SP) will not permit change in the value of respective level parameters.
- Continuous operation of keys for SP or other parameters makes Update speed faster in 3 stages after 3 seconds.

Programming Setpoint (Online):

Default: 50

To view setpoint: Press the key.
To increase/decrease setpoint: Press keys.

INPUT RANGES (Table 1)

FOR RTD

| Input | °C | Ranges |
|-------|----|-------------|
| Pt100 | °C | -150 to 850 |
| | °F | -199 to 999 |

FOR THERMOCOUPLE

| Input | °C | Ranges |
|-------|----|-------------|
| J | °C | -199 to 750 |
| | °F | -199 to 999 |
| K | °C | -199 to 999 |
| | °F | -199 to 999 |
| T | °C | -199 to 400 |
| | °F | -199 to 750 |
| R & S | °C | 0 to 999 |
| | °F | 32 to 999 |

ERROR DISPLAY (Table 2)

When an error has occurred, the display indicates error codes as given below.

| Error | Meaning | Control Output Status |
|-------|--|-----------------------|
| SbE | Sensor break / Over range condition | OFF |
| SrE | Sensor reverse / Under range condition | OFF |

(Specifications are subject to change, since development is a continuous process)

Selec Controls Pvt. Ltd.

Tel. No. : +91-22-40394200 / 40394202

Fax No. : +91-22-28471733 Toll free : 1800 227 353

Website: www.selec.com Email: sales@selec.com