

PRODUCT PROFILE

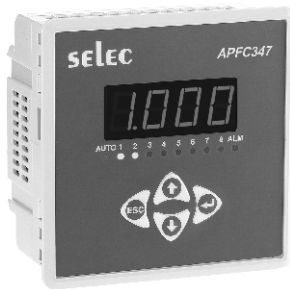

96 x 96mm

SPECIFICATIONS

Display	: 4 Digit, 7 Segment LED display, height : 0.56"				
Auxiliary Supply	: 85-270V AC, 50-60Hz				
Wiring Input	: LN / L-L				
Rated input voltage	: 40-300V(L-N), 50-530V(L-L), 45-65Hz				
Rated input current	: Nominal 5A AC (MIN 50mA, MAX 6A), Single CT Sensing				
Burden	: 20 mOhms				
CT Primary	: 1-9999A(For CT,S=1) ; 5-9999A(For CT,S=5)				
CT Secondary	: 1 or 5A				
No of Relay Stages	: For APFC347-108 : 8 Relay For APFC347-106 : 6 Relay For APFC347-104 : 4 Relay				
Trip indication	: Alarm relay turns ON & ALM (Alarm) LED blinks (Refer LED indication chart)				
Controlling Range	: Target PF : 0.8 lag to 0.8 lead Control sensitivity : 55 to 100% Step time : 1 to 999 Sec. Discharge time : 1 to 999 Sec. Switching program : Automatic/Linear/Rotational Control Mode : Automatic/Manual Auto initialization : Yes / No				
Output	: Relay output Alarm mode : Under voltage, Over voltage, CT polarity error, Under compensate, Over compensate				
Programmable Hysteresis	: Voltage : 1 to 10% Power Factor : 1 to 5%				
Power Consumption	: 7 VA max.				
Environmental Condition	: Operating : 0°C to 60°C Storage : -20°C to 60°C				
Humidity	: 0% to 95% without moisture consideration				
Accuracy	: <table border="1" style="display: inline-table; vertical-align: middle;"> <tr> <th>Measurement</th> <th>Accuracy</th> </tr> <tr> <td>Power factor</td> <td>±0.01</td> </tr> </table>	Measurement	Accuracy	Power factor	±0.01
Measurement	Accuracy				
Power factor	±0.01				
Mounting	: Panel Mounting				
Weight	: APFC347-108 : 263 gms APFC347-106: 258 gms APFC347-104 : 253 gms				

ORDER CODE INFORMATION

PRODUCT	SUPPLY	CE	NO. OF STAGES
APFC347-108-230V	85 to 270V AC, 50/60Hz	—	8
APFC347-106-230V	85 to 270V AC, 50/60Hz	—	6
APFC347-104-230V	85 to 270V AC, 50/60Hz	—	4

SAFETY PRECAUTIONS

All safety related codification, symbols and instructions that appear in this operating manual or on the equipment must be strictly followed to ensure the safety of the operating personnel as well as the instrument.

If the equipment is not handled in a manner specified by the manufacturer, it might impair the protection provided by the equipment.

CAUTION : Read Complete instruction prior to installation and operation of the unit.

WARNING : Risk of electric shock.

WIRING GUIDELINES

- To prevent the risk of electric shock, power supply to the equipment must be kept OFF while doing the wiring arrangement. Do not touch the terminals while power is being supplied.
- Wiring shall be done strictly according to the terminal layout. Confirm that all connections are correct.
- Use pin type lugged terminals.
- To eliminate electromagnetic interference, use wires with adequate ratings and twists of the same in equal size shall be made.
- Cables used for connection to power source, must have a cross section of 1.5mm². These wires shall have current carrying capacity of 5A.

MAINTENANCE

- The equipment should be cleaned regularly to avoid blockage of ventilating parts.
- Clean the equipment with a clean soft cloth. Do not use Isopropyl alcohol or any other cleaning agent.

INSTALLATION GUIDELINES

CAUTION

- This equipment, being built-in type, normally becomes a part of main control panel and in such case the terminals do not remain accessible to the user end after installation and internal wiring.
- Conductors must not come in contact with the internal circuitry of the equipment or else it may lead to a safety hazard that may in turn endanger life or cause electrical shock to the operator.
- Before disconnecting the secondary of the external current transformer from the equipment, make sure that the current transformer is short circuited to avoid risk of electrical shock and injury.
- The equipment shall not be installed in environmental condition other than those mentioned in this manual.
- Thermal dissipation of equipment is met through ventilation holes provided on chasis of equipment. Such ventilation holes shall not be obstructed else it can lead to a safety hazard.
- Connector screw must be tightened after installation.

MECHANICAL INSTALLATION / DIMENSIONS

- For installing the meter
- Prepare the panel cutout with proper dimensions as shown below.
 - Push the meter into the panel cutout. Secure the meter in its place by fitting the clamp on the rear side. fit clamps on both sides in diagonally opposite location for optimum fitting.
 - For proper sealing, tighten the screws evenly with required torque.

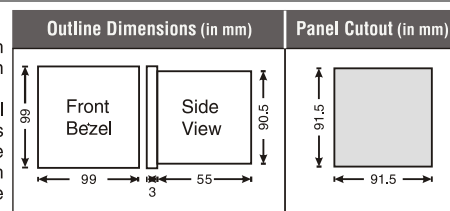

MAINTENANCE

- The equipment should be cleaned regularly to avoid blockage of ventilating parts.
- Clean the equipment with a clean dry or damp cloth. Do not use any cleaning agent other than water.

EMC GUIDELINES

- Use proper input power cables with shortest connections and twisted type.
- Layout of connecting cables shall be away from any internal EMI source.

FRONT PANEL DESCRIPTION

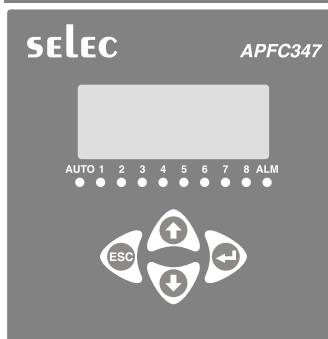

NOTE : The setting should be done by a professional after going through this operating manual.

CONFIGURATION

There are 4 dedicated keys . Use these 4 keys to enter into configuration menu / change setting.

KEY DESCRIPTION

Press	For 3 sec to enter or exit from the configuration menu.
Press	For increment
Press	For decrement
Press	To save the setting and move on to next page
Press	To go back

LED INDICATIONS

LED	DESCRIPTION
1 to X [X = 8 / 6 / 4]	Capacitor Banks that are ON.
AUTO	Indicates controller is in AUTO mode.
AUTO	Indicates controller is in MANUAL mode.
ALM	No fault condition present.
ALM [Blinking]	Fault condition occurred [Press ENTER key to display trip parameter.]
ALM	This will take place when user will press ENTER key in fault condition. Trip parameters will be displayed for 3sec each.

NOTE : On occurrence of any new fault condition ALM LED starts blinking again & on pressing ENTER key all trip parameters will be displayed for 3sec each.

SERIAL NUMBER DESCRIPTION

Press ESC () key for 10sec. to display 8 digit serial number.

Example : Sr. No. 12345678

Press ESC () key for 10sec.

Displays 1234 for 3 sec.

After 3 sec. displays 5678 for 3 sec.

USER GUIDE

a) Manual switching (MANL)

When this switching program is selected, the capacitor steps are controlled manually by the user.

b) Rotational switching (ROTN)

This switching program is based on rotational first-in-first-out sequence. This option will automatically switch in and out the capacitors according to the targeted power factor, sensitivity setting and the re-connection time setting.

c) Automatic switching (AUTO)

This automatic switching program uses intelligent switching sequence. The step switching sequence is not fixed and the program automatically selects the most appropriate steps to switch in or out in order to achieve shortest reaction time with minimum number of steps.

d) Linear switching (LINR)

In this switching sequence it works in last in first out mode. This option will automatically switch in and out the capacitors according to the targeted power factor, sensitivity setting and the re-connection time setting.

CONFIGURATION MENU

MAIN MENU	LEVEL	SUB MENU
Installation Password (PW1)	LE-1	Change Password Yes / No New Password CT Primary CT Secondary Network Selection Phase Compensation Nominal Voltage Threshold Voltage Auto Initialization Max Relay No. Mode Switching Program Target P.F Step Time Discharge Time Control Sensitivity Setting Low Current Setting
		CPYd NPYd CTP CTS NETY PCRA VOLTE UETH R.INE NLY N0DE SYPG LPPF STEPE DISL CSNS LCUR
		<ul style="list-style-type: none"> • After entering into PW1, sub menu of LE-1 will be selected. • To scroll through sub menu press increment or decrement key.
Technical Password (PW2)	LE-1	Change Password Yes / No New Password CT Primary CT Secondary Network Selection Phase Compensation Nominal Voltage Threshold Voltage Auto Initialization Max Relay No. Mode Switching Program Target P.F Step Time Discharge Time Control Sensitivity Setting Low Current Setting
		CPYd NPYd CTP CTS NETY PCRA VOLTE UETH R.INE NLY N0DE SYPG LPPF STEPE DISL CSNS LCUR
		Over Voltage Over Voltage Setting Under Voltage Under Voltage Setting Over Compensation Under Compensation CT Polarity Error Hysteresis Voltage Hysteresis Power Factor Factory Default
	OULTE OUS UULTE UUS OCAP UCAP CTER HULTE HPPF DFLT	
	LE-3	Bank 1 Bank 2 Bank 3 Bank 4 Bank 5 Bank 6 Bank 7 Bank 8 RL01 RL02 RL03 RL04 RL05 RL06 RL07 RL08 Note : LE-3 will be prompted only when mode is set to manual in LE-1 RL.01-RL.08 applicable only for APFC347-108; RL.01-RL.06 applicable only for APFC 347-106 ; RL.01-RL.04 applicable only for APFC347-104
		<ul style="list-style-type: none"> • After entering into PW2, all levels can be accessed. • Press ESC Key to change the level. Different level can be selected by pressing increment & decrement Key.

PRESS + KEYS for 3 sec. to enter or exit from configuration menu.

Password
 PSYd

Note : Appearance of shaded menus dependent on selection of other parameters.

LEVEL 1				
Display	Description	Default Value	Range	Condition
PSWD	Password	10(PW1); 11(PW2)	0000 - 9999	
C.PWD	Change Password	NO	NO / YES	
N.PWD	New Password	0	0000 to 9999	This option will be prompted only when C.PWD set to YES.
CT.P	CT Primary	5	5 to 9999	1 to 9999 (CT.S=1) 5 to 9999 (CT.S=5)
CT.S	CT Secondary	5A	1A / 5A	
NETW	Network Selection	L-L	LN / LL	
PCMA	Phase compensation	90	0°, 90°, 120°, 210°, 240°, 330°	
VOLT	Nominal Voltage	240V (L-N) 415V (L-L)	50V-550V	
V.TH	Voltage Threshold	0	0% to 100%	
A.INT	Auto Initialization	YES	NO / YES	
*RLY	Max Relay Numbers	8/6/4	3 to 8/6/4	
MODE	Mode	AUTO	AUTO / MANL	
SWPG	Switching Program	AUTO	Automatic (AUTO)	
			Linear (LINR)	
			Rotational (ROTN)	
T. PF	Targeted P. F	1.000	-0.800 to 0.800	
STP.T	STEP TIME	5	1-999s	
DIS.T	Discharge time (Reconnection time)	180	1-999s	
C.SNS	C/K Setting	60	55% to 100%	
L.CUR	Low current setting	0	0-50%	

* 8 Relay : Applicable only for APFC347-108
6 Relay : Applicable only for APFC347-106
4 Relay : Applicable only for APFC347-104

NOTE :

- Auto - Initialization (A.INT) is working at best, under stable load conditions.
- Auto- Initialization (A.INT) works only with capacitor banks and not with reactors.
- If V.TH value is set to zero, A.IN will be done only at power ON.
- Recommended that number of relays not to be changed during normal operation. If done so, restart the unit.
- Recommended to restart the unit if Switching program(SWPG) is changed during normal operation for proper functionality in accordance with the chosen control mode.
- A.INT will be update 'NO' automatically in configure after Auto initialization
- Reauto - Initialization will be done by only changing A.INT - YES in configure manually
- When condition of low current occurs, the display of controller will show the 'CURR'.

LEVEL 2

Display	Description	Default Value	Range	Condition
O.VLT	Over voltage	ON	ON / OFF	
OV.S	Over voltage setting	256(L-N) 540(L-L)	256V to 264V (L-N) 540V to 570V (L-L)	This option will be prompted only when O.VLT option made ON.
U.VLT	Under voltage	OFF	ON / OFF	
UV.S	Under voltage setting	195(L-N) 380(L-L)	195V to 204V (L-N) 380V to 480V (L-L)	This option will be prompted only when U.VLT option made ON.
O.CMP	Over compensation	ON	ON / OFF	
U.CMP	Under compensation	ON	ON / OFF	
CT.ER	CT Polarity error	ON	ON / OFF	
H.VLT	Hysteresis voltage	2	1% to 10%	
H.PF	Hysteresis power factor	1	1% to 5%	
DFLT	Factory default	NO	NO / YES	

LEVEL 3

Display	Description	Default Value	Range	Condition
RL.01	Bank 1	OFF	ON / OFF	Prompted only if MODE is set to MANUAL
RL.02	Bank 2	OFF	ON / OFF	
RL.03	Bank 3	OFF	ON / OFF	
RL.04	Bank 4	OFF	ON / OFF	
RL.05	Bank 5	OFF	ON / OFF	
RL.06	Bank 6	OFF	ON / OFF	
RL.07	Bank 7	OFF	ON / OFF	
RL.08	Bank 8	OFF	ON / OFF	

Note : RL.01-RL.08 applicable only for APFC347-108
RL.01-RL.06 applicable only for APFC 347-106
RL.01-RL.04 applicable only for APFC347-104

WIRING DIAGRAM

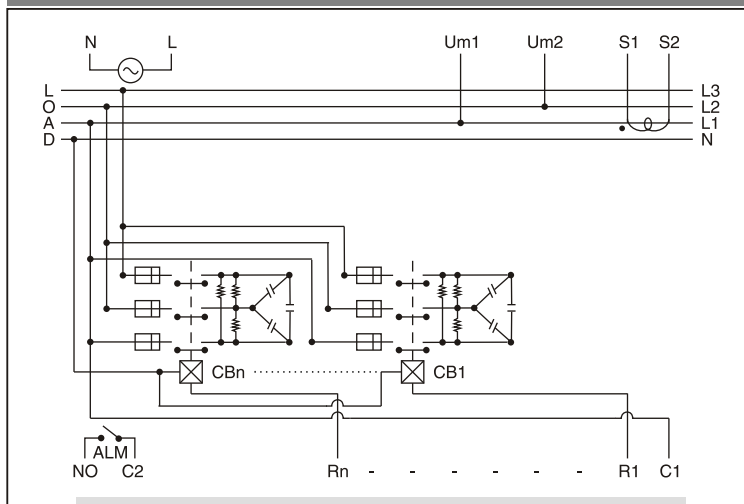

Where,

Um1 & Um2 - Input Voltage of Phase or phase to Phase
S1 & S2 - CT Input
R1... Rn - Relay to switch capacitor
CB1... CBn - Capacitor banks
n - 4 for APFC347-104
n - 6 for APFC347-106
n - 8 for APFC347-108
C1, C2 - Relay COM
NO - Normally Open

PHASE-ANGLE SETTING

Voltage	L1-N	L2-N	L3-N	L1-N	L2-N	L3-N	L1-N	L2-N	L3-N
CT	L1	L2	L3	L2	L3	L1	L3	L1	L2
Phase-Angle	0°	0°	0°	240°	240°	240°	120°	120°	120°
Voltage	L2-L3	L3-L1	L1-L2	L2-L3	L3-L1	L1-L2	L2-L3	L3-L1	L1-L2
CT	L1	L2	L3	L2	L3	L1	L3	L1	L2
Phase-Angle	90°	90°	90°	330°	330°	330°	210°	210°	210°

(Specifications are subject to change, since development is a continuous process.)

Selec Controls Pvt. Ltd., India

Factory Address :
EL-27/1, Electronic Zone, TTC Industrial Area, MIDC, Mahape, Navi Mumbai - 400 710, INDIA.
Tel. No. : +91-22-41 418 419/430 | Fax No. : +91-22-28471733
Toll free : 1800 227 353 (BSNL/MTNL Subscribers only)
Website : www.selec.com | Email : sales@selec.com