



SPECIFICATIONS

Display

3 + 3 digit, 7 segment digital display

LED Indications

R : Control output ON

Keys

3 keys for digital setting

INPUT SPECIFICATIONS

Input Signal

Thermocouple (J, K, T, R, S) / RTD (Pt100)

Sampling time

250 ms

Input Filter (FTC)

0.2 to 10.0 sec

Resolution

Fixed 1° resolution

Temperature Unit

°C / °F selectable

Indication Accuracy

For TC inputs : 0.25% of FS ±1°
 For R & S inputs : 0.5% of F.S ± 2°
 (20 min of warm up time for TC inputs)
 For RTD inputs : 0.1% of FS ±1°

FUNCTIONAL SPECIFICATIONS

Control Method

- 1) PID control with auto tuning
- 2) ON-OFF control

Proportional Band (P)

1 to 400°

Integral Time (I)

0.0 to 99.9 min

Derivative Time (D)

0 to 999 sec

Cycle Time

0.1 to 99.9 sec

Hysteresis Width

0.1 to 99.9°

Manual Reset Value

-19.9 to 19.9°

CONTROL OUTPUT : Relay or SSR

(One output at a time)

Relay contact (SPDT)

10 A @ 250V AC / 30V DC, resistive

SSR Drive Output (Voltage Pulse)

12V DC, 50 mA

POWER SUPPLY

Supply Voltage

85 to 270V AC/DC (AC : 50 or 60Hz)
 OPTIONAL - 24V AC/DC

Power Consumption

5VA max @230V AC

Temperature

Operating : 0 to 50°C ; Storage : -20 to 75°C

Humidity (non-condensing)

95% RH

Weight

TC533AX : 129 gms

TC233AX : 180 gms

TC333AX : 240 gms

SAFETY PRECAUTIONS

All safety related codifications, symbols and instructions that appear in this operating manual or on the equipment must be strictly followed to ensure the safety of the operating personnel as well as the instrument.

If the equipment is not handled in a manner specified by the manufacturer it might impair the protection provided by the equipment.

Read complete instructions prior to installation and operation of the unit.

WARNING : Risk of electric shock.

WIRING GUIDELINES

WARNING :

1. To prevent the risk of electric shock power supply to the equipment must be kept OFF while doing the wiring arrangement. Do not touch the terminals while power is being supplied.
2. To eliminate electromagnetic interference use short wire with adequate ratings ; twists of the same in equal size shall be made. For the input and output signal lines, be sure to use shielded wires and keep them away from each other.
3. Cable used for connection to power source, must have a cross section of 1mm² or greater. These wires shall have insulation capacity made of at least 1.5kV.
4. When extending the thermocouple lead wires, always use thermocouple compensation wires for wiring. For the RTD type, use a wiring material with a small lead resistance (5Ω max per line) and no resistance differentials among three wires.
5. A better anti-noise effect can be expected by using standard power supply cable for the instrument.

MAINTENANCE

1. The equipment should be cleaned regularly to avoid blockage of ventilating parts.
2. Clean the equipment with a clean soft cloth. Do not use Isopropyl alcohol or any other cleaning agent.

INSTALLATION GUIDELINES

1. This equipment, being built-in-type, normally becomes a part of main control panel and in such case the terminals do not remain accessible to the end user after installation and internal wiring.
2. Do not allow pieces of metal, wire clippings, or fine metallic fillings from installation to enter the product or else it may lead to a safety hazard that may in turn endanger life or cause electrical shock to the operator.

3. Circuit breaker or mains switch must be installed between power source and supply terminals to facilitate power 'ON' or 'OFF' function. However this switch or breaker must be installed in a convenient position normally accessible to the operator.
4. Use and store the temperature controller within the specified ambient temperature and humidity ranges as mentioned in this manual.

CAUTION

1. When powering up for the first time, disconnect the output connections.
2. Fuse Protection : The unit is normally supplied without a power switch and fuses. Make wiring so that the fuse is placed between the mains power supply switch and the controller. (2 pole breaker fuse- rating : 275V AC,1A for electrical circuitry is highly recommended)
3. Since this is a built-in-type equipment (finds place in main control panel), its output terminals get connected to host equipment. Such equipment shall also comply with basic EMI/EMC and other safety requirements like BSEN61326-1 and BSEN61010 respectively.
4. Thermal dissipation of equipment is met through ventilation holes provided on chassis of equipment. Such ventilation holes shall not be obstructed else it can lead to a safety hazard.
5. The output terminals shall be strictly loaded to the manufacturer specified values/range.

MECHANICAL INSTALLATION

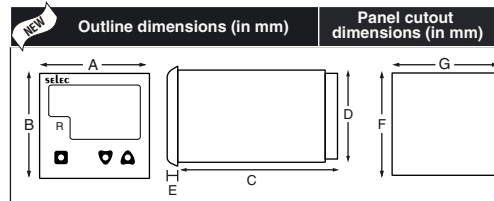

MODELS	DIM						
	A	B	C	D	E	F	G
TC533AX	52	52	94	45	4	46	46
TC233AX	72	72	83.7	67	4.5	69	69
TC333AX	96	96	73	90.5	5	92	92

1. Prepare the panel cutout with proper dimensions as shown above.
2. Remove the clamp from the controller and push the controller into the panel cutout. Insert the clamp from the rear side until the main unit is securely fit into the panel.
3. The equipment in its installed state must not come in close proximity to any heating sources, caustic vapors, oils, steam, or other unwanted process by-products.
4. Use the specified size of crimp terminals (M3.5 screws) to wire the terminal block. Tighten the screws on the terminal block using the tightening torque within the range of 1.2 N.m.
5. Do not connect anything to unused terminals.

EMC Guidelines :

1. Use proper input power cables with shortest connections and twisted type.
2. Layout of connecting cables shall be away from any internal EMI source.

LOAD CONNECTIONS

1. The service life of the output relays depends on the switching capacity and switching conditions. Consider the actual application conditions and use the product within the rated load and electrical service life.
2. Although the relay output is rated at 10 amps it is always necessary to use an interposing relay or contactor that will switch the load. This avoids damage to the controller in the event of a fault short developing on the power output circuit.
3. Always use a separate fused supply for the "power load circuit" and do not take this from the live and neutral terminals supplying power to the controller.

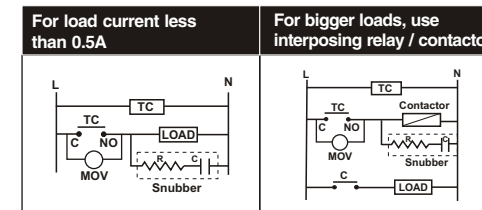

ELECTRICAL PRECAUTIONS DURING USE

Electrical noise generated by switching of inductive loads can create momentary disruption, erratic display, latch up, data loss or permanent damage to the instrument.

To reduce noise :

- a) Use of snubber circuits across loads as shown above, is recommended.
- b) Use separate shielded wires for inputs.

TERMINAL CONNECTIONS

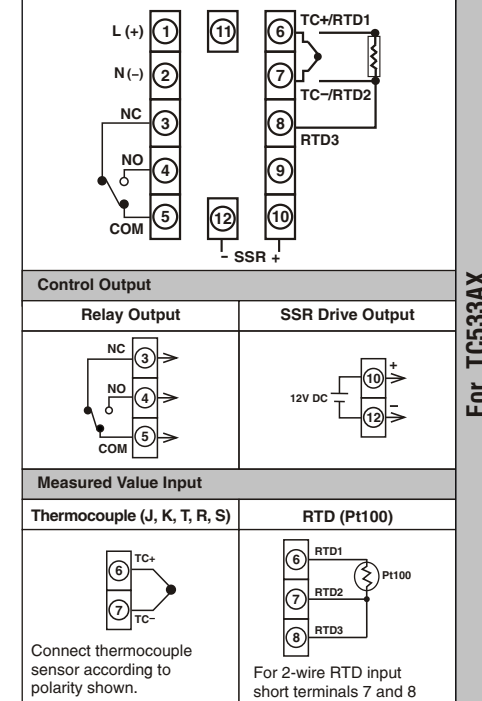

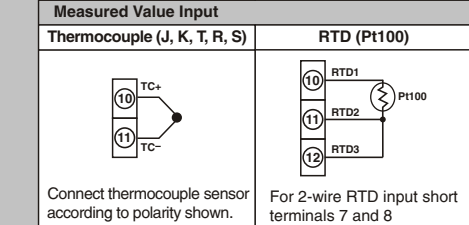
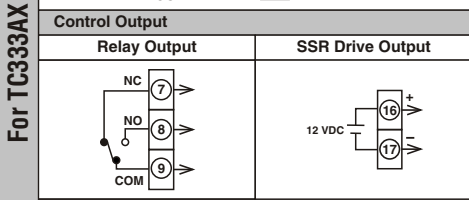
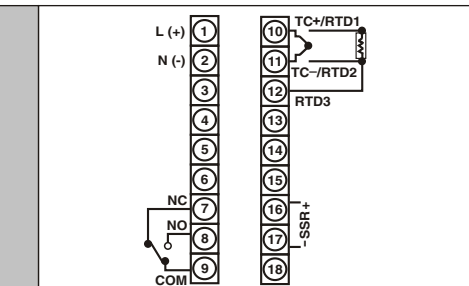
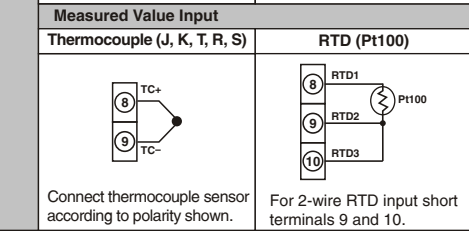
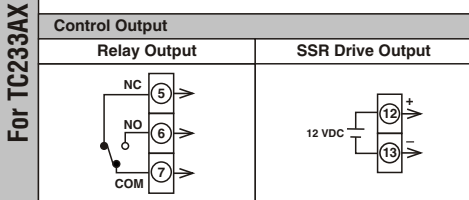
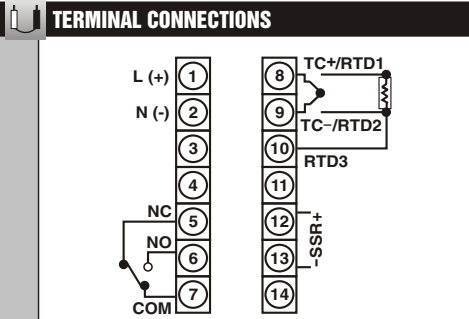

WARNING : Please check the power supply voltage and controllers output type ordered (with reference to the order code) before installation.

Use only the correct thermocouple wire or compensating cable from the probe to instrument terminals avoiding joints in the cable if possible. Failure to use the correct wire type will lead to inaccurate readings. Ensure that the input sensor connected at the terminals and the input type set in the temperature controller configuration are the same.

FRONT PANEL DESCRIPTION

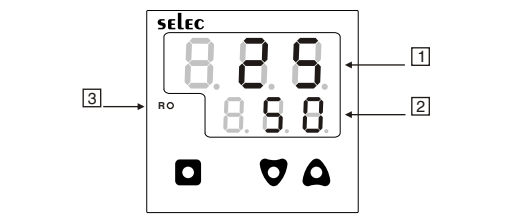

1 Process-value (PV) / Parameter name display	1) Displays a process value (PV). 2) Displays the parameter symbols at parameter setting mode. 3) Displays PV error conditions. (refer Table 2)
2 Set-value (SV) / Parameter setting display	1) Displays a set value (SV). 2) Displays the parameter settings at parameter setting mode.
Tune	1) Auto tune: Lower display alternate between AT & setpoint
3 Control output indication	The LED is lit when the control output is ON

FRONT KEYS DESCRIPTION

Functions	Key press
Online	
To view Level 1	Press key for 3 seconds.
To view Level 2	Press key for 3 seconds.
To view Protection Level	Press + keys for 3 seconds.
To view and change setpoint value	Press to view the setpoint. Press + key to change the setpoint.

Programming Mode

To view parameters on the same level.	or key once to view the next or previous function in operational menu.
To increase or decrease the value of a particular parameter.	+ to increase and + to decrease the function value. Note: Parameter value will not alter when respective level is locked.

NOTE: The unit will auto exit programming mode after 30 seconds of inactivity.
 By pressing the or or + keys for 3 seconds.

USER GUIDE

1. Display Bias:
 This function is used to adjust the PV value in cases where it is necessary for PV value to agree with another recorder or indicator, or when the sensor cannot be mounted in correct location.

2. Filter Time Constant
 The input filter is used to filter out quick changes that occur to the process variable in a dynamic or quick responding application which causes erratic control. The digital filter also aids in controlling processes where the electrical noise affects the input signal. Larger the value of FTC entered, greater the filter added and the slower the controller reacts to the process and vice versa.

3. Auto tuning:
 The Auto-tuning function automatically computes and sets the proportional band (P), integral time (I), Derivative time (D), ARW% and cycle time (CY.T) as per process characteristics.
 • While Auto-tune is in progress, lower display alternate shows AT & setpoint.
 • Lower display stops alternating between AT & setpoint at the completion of auto-tuning.

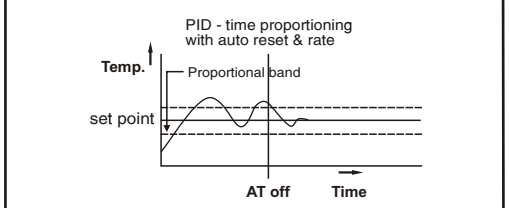

- If the power goes OFF before auto-tuning is completed, auto-tuning will be restarted at next power ON.
- If auto-tuning is not completed after 3-4 cycles, the auto-tuning is suspected to fail. In this case, check the wiring & parameters such as the control action, input type, etc.
- Carry out the auto-tuning again, if there is a change in setpoint or process parameters.

4. ON/OFF control action (For Reverse Mode):
 The relay is 'ON' up to the set temperature and cuts 'OFF' above the set temperature. As the temperature of the system drops, the relay is switched 'ON' at a temperature slightly lower than the set point.

HYSTERESIS:
 The difference between the temperature at which relay switches 'ON' and at which the relay switches 'OFF' is the hysteresis or dead band.

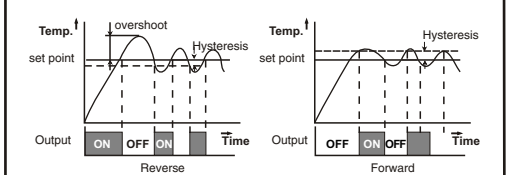

5. Manual Reset (for PID control & I=0):
 After some time the process temperature settles at some point and there is a difference between the set temperature & the controlled temperature. This difference can be removed by setting the manual reset value equal & opposite to the offset.

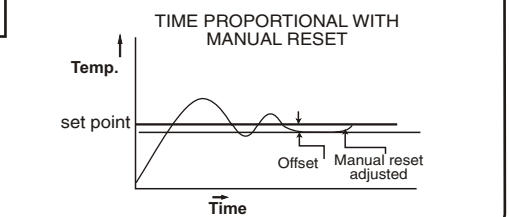

CALIBRATION CERTIFICATE

Date :

Model No :

Claimed Accuracy :
 For TC inputs : 0.25% of FS $\pm 1^\circ$
 For R & S inputs : 0.5% of F.S $\pm 2^\circ$
 (20 min of warm up time for TC input)
 For RTD inputs : 0.1% of FS $\pm 1^\circ$

Sources calibrated against :

Multimeter calibration report no :

The calibration of this unit has been verified at the following values :

SENSOR	CALIBRATION TEMP (°C)	DISPLAY VALUE (°C)
J	35	35
	300	300
	600	600
K	35	35
	500	500
	990	990
PT100	0	0
	400	400
	800	800

The thermocouple / RTD curves are linearised in this microprocessor based product; and hence the values interpolated between the readings shown above are also equally accurate; at every point in the curve.

Unit is accepted as accuracy is within the specified limit of claimed accuracy and certificate is valid upto one year from the date of issue.

CHECKED BY :

CONFIGURATION INSTRUCTIONS

KEY FUNCTIONS

→ Press for 3 sec to enter Level 2 — Press once to view next parameter in configuration menu
 → Press for 3 sec to enter Level 1 Press once to view previous parameter in configuration menu → Press for 3 sec to enter protection Level
 or → Allows the user to increase or decrease associated parameter value or or → To exit configuration menu press any of these keys for 3 sec.

OPERATIONAL MENU

POWER ON

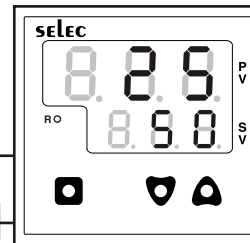

Note : At power ON lower display shows (momentary) input type selected in Level 1.

Press key for 3 sec.

Press key for 3 sec.

Press keys for 3 sec.

Level 1				
Display	Description	Default Value	Range	Display Condition
Input	Input type (Refer Table 1)	J	J/K/T/R/S/RTD	—
Unit	Temperature unit	°C	°C/°F	—
SP.L	Set point low limit	-19.9	Min range of sensor selected to SP.H	—
SP.H	Set point high limit	15.0	SP.L to Max range of sensor selected	—
Filter	Filter time constant (Refer user guide)	1.0	0.2 to 10.0 sec	—
Control	Control action	RE	RE/FD	—
Logic	Control logic	PID	PID/ONF	—
Anti	Anti reset windup %	25	1 to 100 %	For CNT=PID
Factory	Factory default (Reset all)	NO	NO/YES	—

Level 2				
Display	Description	Default Value	Range	Display Condition
Time	Tune (Refer user guide)	0.0	OFF/ON	For CNT=PID
P	Proportional band	1.0	1 to 400°	For CNT=PID
I	Integral time	2.0	0.0 to 99.9 min	For CNT=PID
d	Derivative time	3.0	0 to 999 sec	For CNT=PID
Cycle	Cycle time mode	AUT	AUT/US.F	For CNT=PID
Cycle	Cycle time	15.0	0.1 to 99.9 sec	For CNT=PID
Hyst	Hysteresis	1.0	0.1 to 99.9°	For CNT=ONF
Reset	Manual reset (Refer user guide)	0.0	-19.9 to 19.9°	For CNT=PID & I=0
bias	Display bias (Refer user guide)	0.0	-19.9 to 19.9°	—

Protection Level				
Display	Description	Default Value	Range	Display Condition
SP	Lock setpoint	UNK	UNK/LCK	—
L1	Lock Level 1	UNK	UNK/LCK	—
L2	Lock Level 2	UNK	UNK/LCK	—

Note

- Locking parameters (LV1 or LV2 or SP) will not permit change in the value of respective level parameters.
- Continuous operation of keys for SP or other parameters makes update speed faster in 3 stages after 3 seconds.

Programming Setpoint (Online): Default: 50
Range: SP.L to SP.H
To increase/decrease setpoint: Press keys.

INPUT RANGES (Table 1)

FOR RTD

INPUT	RANGES	
Pt100	°C	-150 to 850
	°F	-199 to 999

FOR THERMOCOUPLE

INPUT	RANGES	
J	°C	-199 to 750
	°F	-199 to 999
K	°C	-199 to 999
	°F	-199 to 999
T	°C	-199 to 400
	°F	-199 to 750
R & S	°C	0 to 999
	°F	32 to 999

ERROR DISPLAY (Table 2)

When an error has occurred, the upper display indicates error codes as given below.

Error	Meaning	Control Output Status
S.b	Sensor break / Over range condition	OFF
S.r	Sensor reverse / Under range condition	OFF

(Specifications are subject to change, since development is a continuous process)

Selec Controls Pvt. Ltd.

Tel. No. : +91-22-40394200 / 40394202
Fax No. : +91-22-28471733 Toll free : 1800 227 353
Website: www.selec.com Email: sales@selec.com