



Features :

- 7" Touch screen
- Ethernet / Serial communication
- User / Password management
- Recipe management
- Data logging functionality
- Update program by USB flash
- Multiple communication protocols
- In-Built symbol library
- Alarms
- Real time clock

Certification :

Display specifications

Type	7" TFT Touch screen (65536 colors)
Resolution	800 x 480 pixels
Display size	7" Diagonal
Backlight	LED
Brightness	300cd/m ²
Span life	30000 hrs
LCD type	4 wire high precision resistance network

Functional specifications

Programming method	Windows based software for HMI configuration.
Processor	A8 600MHz
Memory	256M Flash+256M DRAM
USB host	USB2.0 x 1, Support USB flash disk to update firmware, configure and store data
USB slave	Type B, program download/upload only
Serial interface	COM1:RS485/422 COM2:RS232 COM3:RS485
Ethernet	RJ45 10M/100M self-adaption. Communicates with PLC & PC, Multiple HMI Online. Default IP is 192.168.1.100
DB9	Male (COM1 and COM2)

Mechanical specifications

Dimensions (W x H x D)mm	200 x 146 x 32 mm
Panel cutout (W x H)mm	192 x 138 mm
Mounting	Panel mounting
Weight	750 gms
Ingress protection	IP65
Cover material	ABS+PC plastics

Electrical specifications

Power supply voltage	24V DC (20.4~28.8V DC), 0.3A
Rated power	7W
Permissible power loss	10 mSec
Insulation resistance	Over 50 mΩ @ 500V DC
Withstand voltage performance	500V AC 1 min

Environmental specifications

Temperature	Operating : 0 to 50°C Storage : -20 to 60°C
Humidity	10 ~ 90%RH (non condensing)
Seismic performance	10 ~ 25Hz (2G / 30min in x, y, z directions)

Dimension (All Dimensions are in mm)

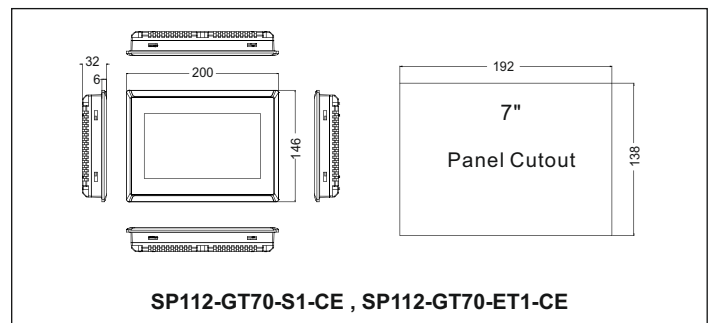

External ports

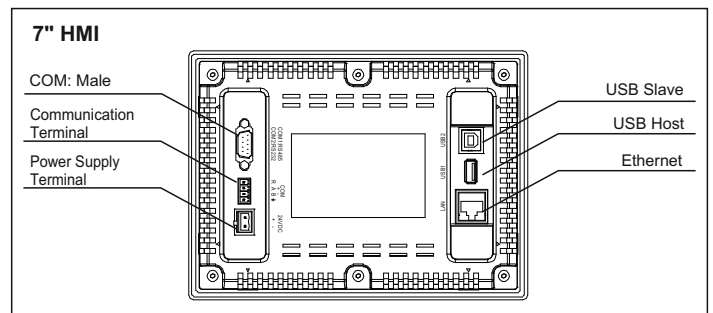

DB9 Pin Configuration

Interface	PIN	PIN Definition
COM2	1	---
	2	RS232 RXD
	3	RS232 TXD
	4	---
	5	GND
COM1	6	---
	7	RS485+(A)
	8	RS485-(B)
	9	---

Caution:
In RS485 communication, out of serial port & communication terminal, only one can be chosen. Two of them can't be used at the same time.

Terminal

Communication Terminal is a 4 pin removable terminal, which supports RS485 communication. A built-in 120 ohm resistance is used for longer distance communication (more than 300-meters), user can manually short Pin 1 & Pin 2 to suppress communication interference.

Port	PIN	Pin Definition	Remarks
COM3	1	R	120Ω Terminal resistance
	2	RS485 +	(A)
	3	RS485 -	(B)
	4	PE	Shield ground

RS485, Terminal connection

Flexys Rail

DIGIX-B

Certification

Protection level of front panel	Comply with IP65 certification (4208-93)
CE certificate	According to CE certification (EN61000-6-2:2005 /EN61000-6-4:2007)

Device interfacing

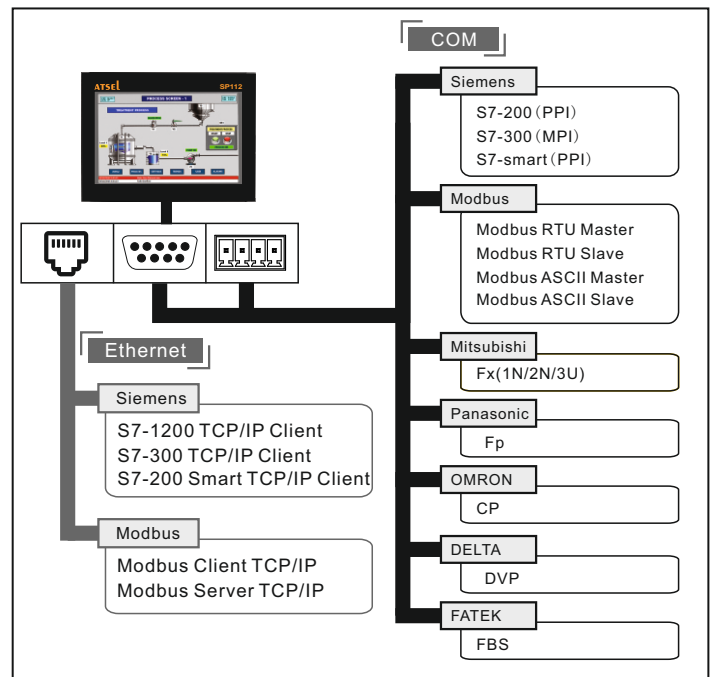

Ordering information

Product code	Description
SP112-GT70-ET1-CE	7" Touch screen HMI with Ethernet & Serial ports
SP112-GT70-S1-CE	7" Touch screen HMI with Serial ports

Accessories

AC-USB-USB-01-1M (USB type B - Downloading cable)