



Figure 1.1(Product Image)

### FEATURES

- PLC with built-in HMI.
- 2 Line x 8 character LCD display.
- RS485 based communication with MODBUS RTU protocol.

### SPECIFICATIONS

<b>Display</b>	2 x 8 LCD(Backlight-yellow-Green, Test Black)	
<b>No. of Keys</b>	5(4- User Configuration)	
<b>Supply Voltage</b>	DIGIX-1-230V-CE	DIGIX-1-0-0-24V-CE
	230V AC(90V - 270V AC)	24V DC (18V to 30V DC)
<b>Sensor Supply (SS)</b>	10V, 50mA	NA
<b>Dimensions</b>	70x90x66.4mm	

### FUNCTIONAL SPECIFICATIONS (CPU)

<b>Programming Language</b>	Windows based user friendly SELPRO software for ladder logic programming and HMI configuration
<b>Memory</b>	Program Memory : 112KB
	Data Memory : 16KB
	EEPROM Memory : 2KB
	VAR_INOUT & VAR_OUTPUT TYPE Variable :- Max 120 bytes retention
<b>Scan Time</b>	Typical 2ms
<b>Functional Blocks</b>	Time ON delay, Timeer OFF Delay, Pulse Timer, Special Timer, Up/Down Counter etc.
<b>Memory Retention</b>	10 Years

### DIGITAL INPUTS

\*1= 90° Phase shift signals

<b>Number of Digital Inputs</b>		8(Including 2 Fast Input)				
<b>Operating Modes (User Configuration)</b>		Unidirectional / Bidirectional / Quadrature / Dual Unidirectional / None				
Channel	DI	MODE				
		UNI	BI	QUAD	DUAL UNI	NONE
FC0	DI0	Rate Totalizer	Rate Totalizer	1st Input*1	Rate Totalizer	Digital Input
	DI1	Digital Input	Direction	2st Input*1	Totalizer	Digital Input

<b>Operating Range</b>	5~30V DC	
<b>Input Current</b>	3mA @ 10V	
<b>Action Level</b>	Level 1 → Level0	<3V DC
	Level 0 → Level 1	≥5V DC
<b>Response Level</b>	Digital Input Mode	Typical 2ms (based on ladder scan time)
	Fast Input mode	100 μsec
<b>Input Impedance</b>	7.5 kΩ	
<b>Debounce Time</b>	0 ~ 255 ms (Default=10ms)	
<b>Maximum Counting Frequency (Fast Input)</b>	5KHz	
<b>Prtection Against Polarity Inversion</b>	Yes	

### RELAY OUTPUTS

<b>Number Of Relay Outputs</b>	5
<b>Output Type</b>	NO Contact Type
<b>Output Contact Rating</b>	5A @28V DC (Resistive)
	5A @240V AC (Resistive)
<b>Response Time</b>	10ms
<b>Life Expectancy</b>	30000 operation at Full Load
<b>Isolation</b>	No
<b>Existence of common points beteen Relay Channels</b>	COM0 for NO0, NO1
	COM1 for NO2, NO3, NO4

### COMMUNICATION DETAILS

<b>Communication Port</b>	RS485 Slave
<b>Communication Protocol</b>	MODBUS RTU
<b>Baud Rate</b>	9600, 19200, 38400, 57600, 115200 (user configuration via software and hardware, Default=19200)

### ENVIROMENTAL CONDITION

<b>Operating Temperature</b>	0 to 55°C
<b>Storage Temperature</b>	-20° to 70°C
<b>Humidity(non-condensing)</b>	95%
<b>Mounting</b>	Din Rail Mounted
<b>Weight</b>	Approx. 240gms

### SAFETY PRECAUTIONS

This manual is meant for personnel involved in wiring installation, operation and routine maintenance of the equipment.

All safety related conditions, symbols and instructions that appear in this operating manual or on the equipment must be strictly followed to ensure operator and instrument safety. Any misuse may impair the protection provided by the equipment.

**CAUTION** : Read complete instructions prior to installation and operation of the unit.

**CAUTION** : Risk of electric shock.

### INSTALLATION INSTRUCTIONS

#### CAUTION

1. This equipment, being built-in-type, normally becomes a part of the main control panel and the terminals do not remain accessible to the user after installation.
2. Conductors must not come in contact with the internal circuitry of the equipment else it may lead to a safety hazard that may endanger life or cause electrical shock to the operator.
3. Circuit breaker or mains switch must be installed between the power source and supply terminals to facilitate power 'ON' or 'OFF' function.
4. The equipment shall not be installed in environmental conditions other than those specified in this manual.
5. Thermal dissipation of equipment is met through ventilation holes provided on housing of equipment. Obstruction of these ventilation holes may lead to a safety hazard.
6. The output terminals shall be loaded strictly as per the values / range specified by the manufacturer.

#### ELECTRICAL PRECAUTIONS DURING USE

Electrical noise generated by switching of inductive loads can create momentary disruption, erratic display, latch up, data loss or permanent damage to the instrument.

#### To reduce noise :

Use of Selec make Snubber across load is recommended.  
Snubber Part no. : SNUBBER

**NOTE** : Below mentioned diagram is applicable only for 230V relay outputs.

### Typical Connections For Loads :

For load current < 0.5A

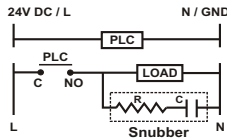

For bigger loads use interposing relay / contactor

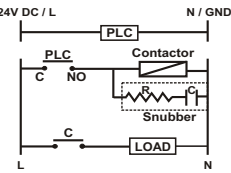

**NOTE :** Use snubber as shown above to increase life of internal relay.

### MECHANICAL INSTALLATION

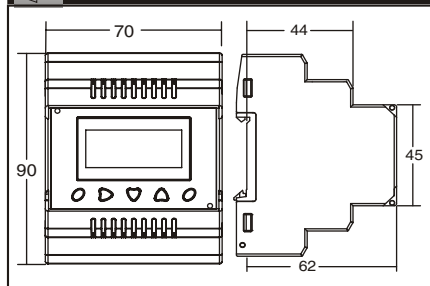

### CAUTION

The equipment in its installed state must not come in proximity to any heating sources, caustic vapors, oils, steam or other unwanted process by products.

### MAINTENANCE

1. To avoid blockage of ventilation holes, clean the equipment regularly using a soft cloth.
2. Do not use Isopropyl alcohol or any other organic Solvents for cleaning.

### WIRING INSTRUCTIONS

### CAUTION

1. To prevent risk of electric shock, power supply to the equipment must be kept OFF while wiring.
2. Terminals and electrically charged parts must not be touched when the power is ON.
3. Wiring shall be done strictly according to the terminal layout provided in the operating manual.
4. To eliminate electromagnetic interference use short wire with adequate ratings and twists of equal size.
5. The power supply connection cable must have a cross section of 1sq.mm or greater and insulation capacity of at least 1.5KV.

### FUNCTIONAL DETAILS

DIGIX-1-X-X-230V-CE-RoHS is a PLC with built in HMI. The user can configure the product using SELPRO software.

### SELPRO has two sections :

1. Ladder logic programming section
2. Selec Machine Interface, used for configuration of HMI.

For details of the software, please refer to the software user manual.

### PANEL MOUNTING

Fig. 1

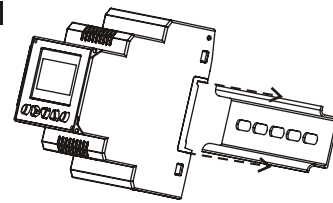
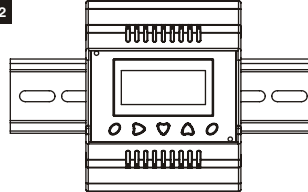
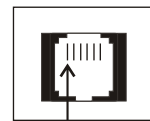

Fig. 2



1. Snap the controller onto the Din Rail as shown in fig. 1 above.
2. When properly mounted, the controller is squarely situated on the Din-rail shown in Fig. 2. above

### INTERNAL PINOUT FOR COMMUNICATION RS485 PORT



PIN	DESCRIPTION
1	RS485+ (Slave)
2	---
3	---
4	---
5	---
6	RS485- (Slave)

### WIRING DIAGRAM

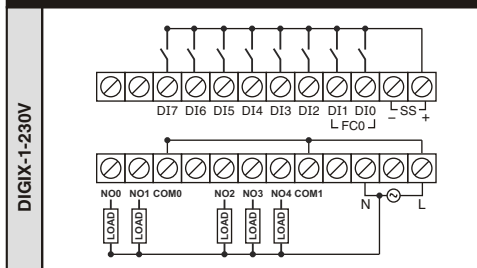

**NOTE :** When DIs are to be connected to External SMPS, then 0V of Ext. SMPS should be looped with SS- of PLC

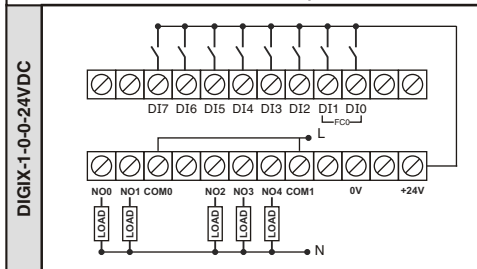

### MENU DESCRIPTION

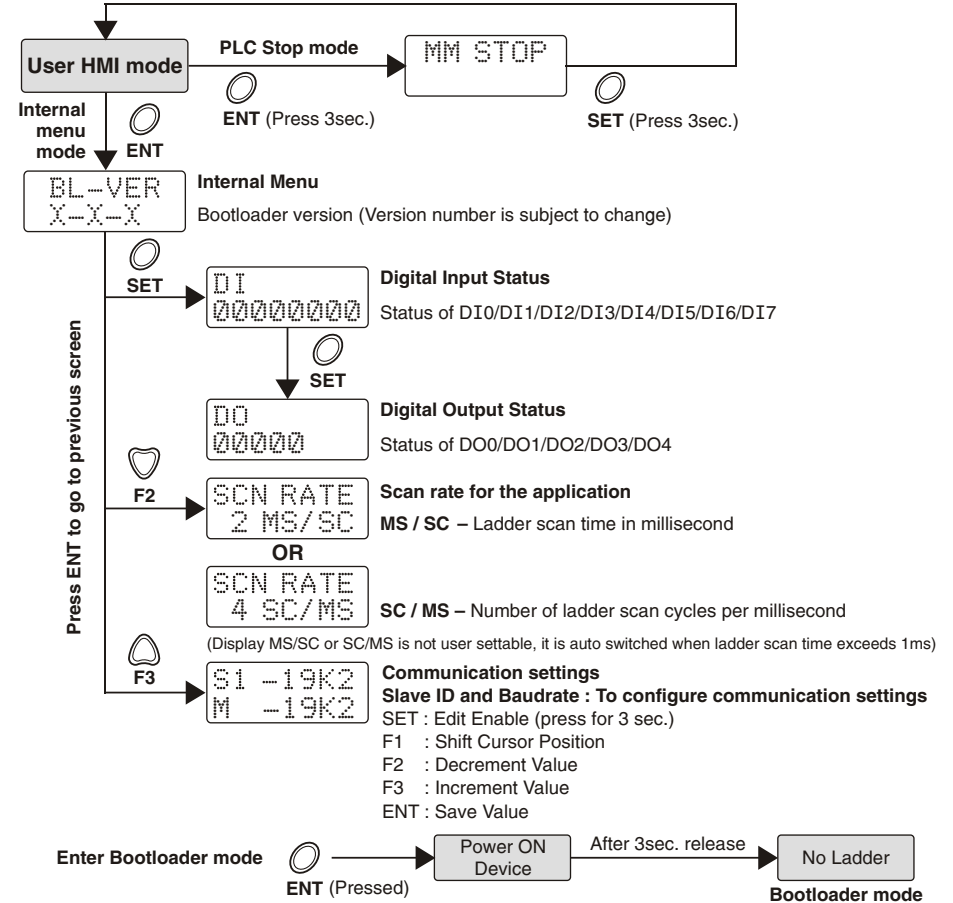

### ACCESSORIES (To be ordered separately)

ORDER CODE	DESCRIPTION
AC-USB-RS485-03	USB to RS485 cable (6 pin jack for downloading)
AC-USB-RS485-02*	USB to RS485 cable (2 pin open wire)
ACH-004	RJ25 (6-pin) cable
AC-IOEXP-03	Port Expansion adapter

**Note:** \* Along with ACH-004 & AC-IOEXP-03 for networking

### ORDER CODE INFORMATION

	CE	UL
DIGIX-1-230V-CE	✓	—
DIGIX-1-0-0-24VDC-CE	✓	—

### SERVICE DETAILS

This device contains no user serviceable parts and requires special equipment and specialized engineers for repair. Please contact service center for repair on the following numbers :  
Tel. No. : + 91-7498077172 ;  
Email : service@selec.com

**NO WARRANTY ON UNIT DAMAGED DUE TO WRONG POWER SUPPLY.**

(Specifications are subject to change, since development is a continuous process.)

### Selec Controls Pvt. Ltd., India

Factory Address :  
EL-27/1, Electronic Zone, TTC Industrial Area, MIDC, Mahape, Navi Mumbai - 400 710, INDIA.  
Tel. No. : +91-22-41 418 419/430 | Fax No. : +91-22-28471733  
Toll free : 1800 227 353 (BSNL/MTNL Subscribers only)  
Website : www.selec.com | Email : sales@selec.com