



SPECIFICATIONS

Display : Dual(3+3) 7 segment LED display

Supply : 85 to 270V AC, 50/60 Hz

Operating Modes : 1) On Delay
2) Interval

3) Cyclic On first

4) Cyclic Off first

Time Ranges : 9.99 / 99.9 / 999 sec

9.59 min:sec, 99.9 / 999 min,

9.59 hour:min, 99.9 / 999 hour

Counting : Down/Up

Direction

Relay Rating : 5A @ 250V AC / 28V DC

Start Input : Pulse, Gate (Programmable)

Reset : On interruption of power, front panel reset & terminal reset

Outputs : 2 Relay (SPDT)

Memory : 10 years

Retention

Accuracy : **Setting** : $\pm 0.05\%$ of set time or 50 msec
(Whichever is greater)

Repeat : $\pm 0.05\%$

Temperature : **Operating** : 0 to 50°C

Storage : -20 to 75°C

Humidity : 95% RH

Housing : PC tinted black

Weight : 120 gms

TERMINAL CONNECTIONS

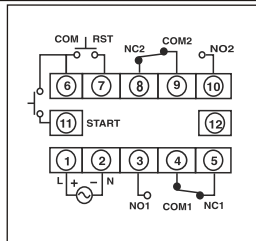

MECHANICAL INSTALLATION

For installing the Timer

1. Prepare the panel cutout with proper dimensions as shown below :

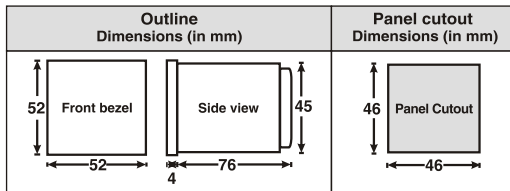

2. Remove the clamp from the controller and push the controller into the panel cutout. Insert the clamp from the rear side until the main is securely fit into the panel.

LOAD CONNECTIONS

For load current less than 0.5A

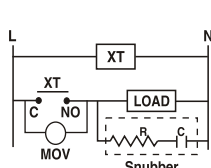

For bigger loads, use interposing relay / contactor

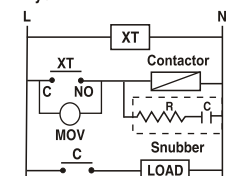

MODE OF OPERATION

1. On delay, Interval modes :

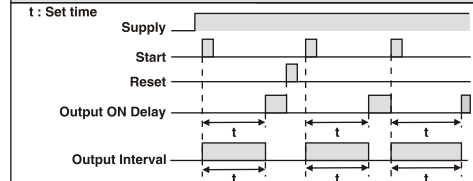

2. Cyclic ON first, Cyclic OFF first modes :

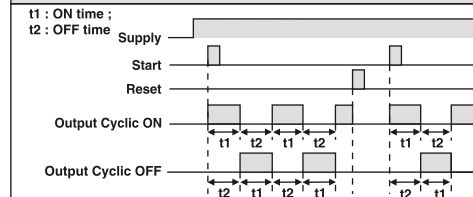

Typical application of Continuous start and reset in On delay mode :

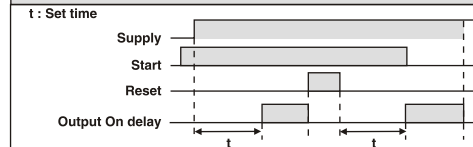

Typical application of Gate start :

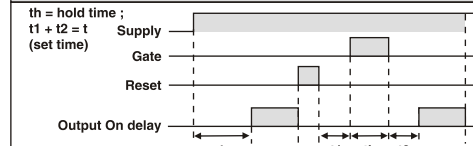

USER GUIDE

START : Pulse / Gate

A) Pulse : Timing starts on momentary closure of switch connected between **START** and **COMMON** terminals.

B) Gate : Timing starts at power ON. When **START & COMMON** is closed timing freezes and it resumes only when the shorting is opened.

FRONT PANEL DESCRIPTION

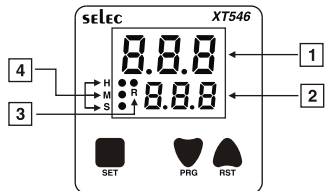

	On line	Config	Lock	For Reset
1	Process Time	Parameter name		
2	Set Time	Parameter setting		
3	Output Status (Lits when Output is ON)			
4	Time Range (Blink in online mode)			

PROTECTION LEVEL

NOTE : Press **▼** + **▲** together continuously for 3sec. to enter into protection level.

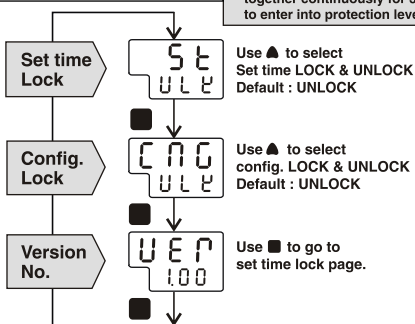

The unit will auto exit lock mode after 30sec. of key inactivity or by pressing **▼** + **▲** keys together continuously for 3sec. to exit the function

CONFIGURATION INSTRUCTION

1. Enter configuration by pressing key **▼** for 3sec.
2. Scroll various function ranges by pressing **▲** & **▼** key.
3. Scroll various parameter by pressing the **■** key.

The unit will auto exit program mode after 30sec. of key inactivity or by pressing **▼** (PROG) key continuously for 3sec.

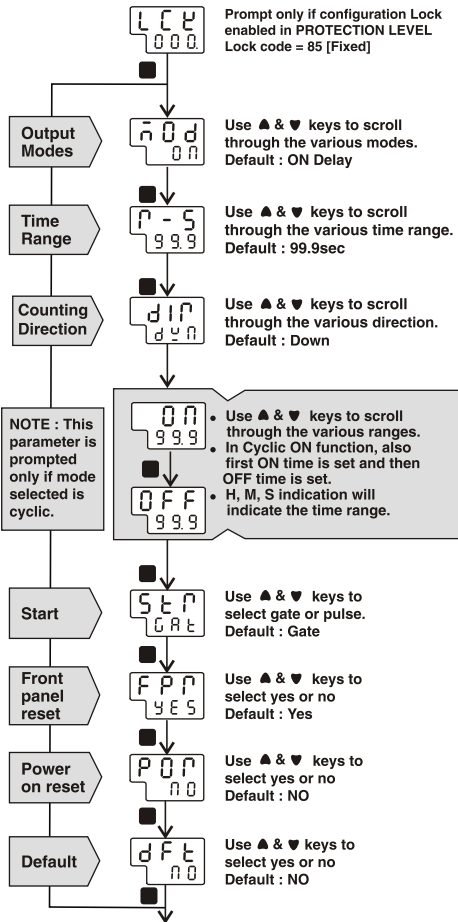

RESET METHOD

NOTE : Press **▲** (RST) key continuously for 3sec. to enter into function.



TO PROGRAM SET VALUE

NOTE : Press **■** key continuous for 3 sec to change the set value. The corresponding digit will increment or decrement from 0 to 9 using **▲** & **▼** respectively.

Only if mode selected is on delay / Interval

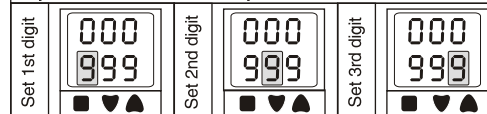

NOTE : Press **■** key to store set value & Press **■** key continuous for 3 sec to exit the set value function .

Only if mode selected is cyclic

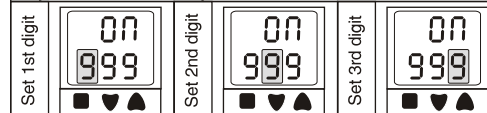

NOTE : Press **■** key continuous for 3 sec to register and move to next parameter

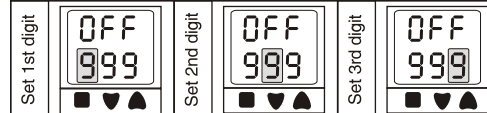

NOTE : Press **■** key to store set value & Press **■** key continuous for 3 sec to exit the set value function .

NOTE : If the set value is 000 then timer must hold (not work). All indications will be OFF.

The unit will auto exit set value mode after 30sec. of key inactivity
(Specifications are subject to change, since development is a continuous process)

Selec Controls Pvt. Ltd. India

Factory Address :

EL-27/1, Electronic Zone, TTC Industrial Area, MIDC, Mahape, Navi Mumbai - 400 710, INDIA.

Tel. No. : +91-22-41 418 452/468 | Fax No. : +91-22-28471733

Toll free : 1800 227 353 (BSNL/MTNL Subscribers only)

Website : www.selec.com | Email : sales@selec.com