



SPECIFICATIONS

- Display** : Dual, 3 digit seven segment LED display
- Supply** : 85 to 270V AC, 50/60 Hz
24V AC / DC (Optional)
- Operating Modes** : On Delay, Interval, Cyclic On first & Cyclic Off first
- Time Ranges** : 9.99 / 99.9 / 999sec
9.59 min:sec, 99.9 / 999 min,
9.59 hour:min, 99.9 / 999 hour
- Counting Direction** : Down
- Relay Rating** : 5A@250V AC / 28V DC
- Start Input** : Pulse, Gate (Programmable)
- Reset** : On interruption of power, front panel reset & terminal reset
- Outputs** : 2 ; 1 C/O (SPDT)
- Memory Retention** : 10 years
- Accuracy** : **Setting** : $\pm 0.05\%$ of set time or 50 msec (Whichever is greater)
Repeat : $\pm 0.05\%$
- Temperature** : **Operating** : 0 to 50°C
Storage : -20 to 75°C
- Humidity** : 95% RH
- Housing** : PC tinted black
- Weight** : **XT546** : 140 gms
XT246 : 190 gms
XT346 : 240 gms

TERMINAL CONNECTIONS

XT546

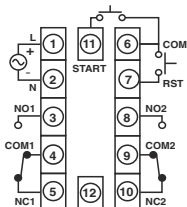

XT246

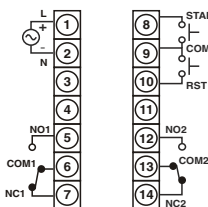

XT346

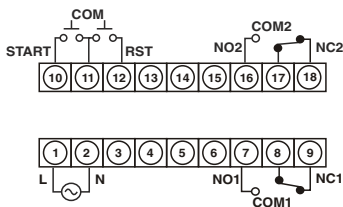

MECHANICAL INSTALLATION

For installing the Timer

1. Prepare the panel cutout with proper dimensions as shown below :

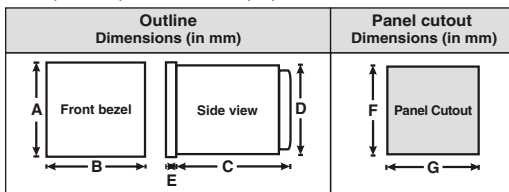

MODELS	DIM	A	B	C	D	E	F	G
XT546		48	48	94	45	4	46	46
XT246		72	72	83.7	67	10	69	69
XT346		96	96	73	90.5	10	92	92

2. Remove the clamp from the controller and push the controller into the panel cutout. Insert the clamp from the rear side until the main is securely fit into the panel.

LOAD CONNECTIONS

For load current less than 0.5A

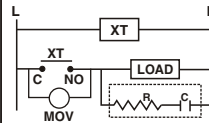

For bigger loads, use interposing relay / contactor

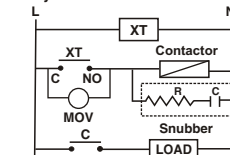

FRONT PANEL DESCRIPTION

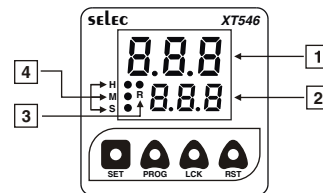

	On line	Config	Lock	For Reset
1	Process Time	Parameter name		
2	Set Time	Parameter setting		
3	O/P Status (Lit when O/P is ON)			
4	Time Range (Blink in online mode)			

PROTECTION LEVEL

NOTE : Press **□+▲** (LCK) key together continuously for 3sec. to enter into protection level.

Set time Lock

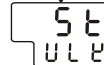

Use **▲** (any of 3) to select set time LOCK & UNLOCK
Default : UNLOCK

Config. Lock



Use **▲** (any of 3) to select config. LOCK & UNLOCK
Default : UNLOCK

The unit will auto exit lock mode after 30sec. of key inactivity or by pressing **□+▲** (LCK) keys continuously for 3sec. to exit the function.

CONFIGURATION INSTRUCTION

1. Enter configuration by pressing the key **□** + **▲** (PROG) key together for 3sec.
2. Scroll various function ranges by pressing **▲** key(any of 3)
3. Scroll various parameter by pressing the **□** key.

The unit will auto exit program mode after 30sec. of key inactivity or by pressing **□** + **▲** (PROG) key together continuously for 3sec.

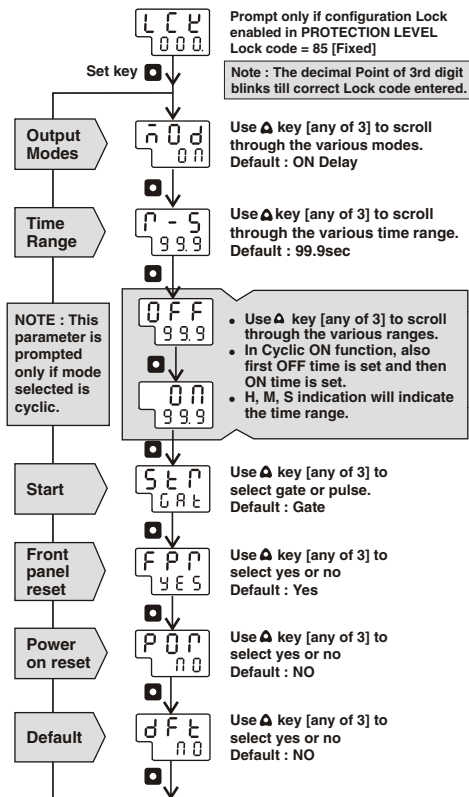

RESET METHOD



NOTE: Press **□** + **▲** (RST) key together continuously for 5sec. to enter into function.

The unit will auto exit reset mode after 1sec.

TO PROGRAM SET VALUE

Note: Press **▲** key to change the set value. The corresponding digit will increment from 0 to 9 and then will roll over back to 0. Press **□** key to store set value

Only if mode selected is on delay / Interval

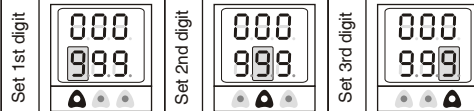

NOTE: Press **□** key to store set value. Decimal point of 3rd digit blink still the storage of setvalue

Only if mode selected is cyclic

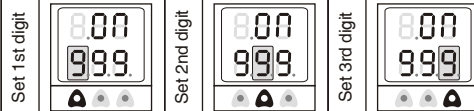

NOTE: Press **□** keys to register and move to next parameter

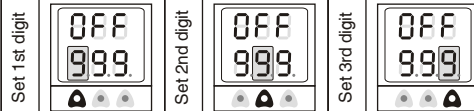

NOTE: Press **□** key to store set value. Decimal point of 3rd digit blinks till the storage of set value

NOTE: If the set value is 000 then timer must hold (not work). All indications will be OFF.

The unit will auto exit set value mode after 30sec. of key inactivity

USER GUIDE

START: Pulse / Gate

- Pulse**: Timing starts on momentary closure of switch connected between **START** and **COMMON** terminals.
- Gate**: Timing starts at power on. When the **START** and **COMMON** terminal is closed timing freezes and it resumes only when the shorting is opened.

MODE OF OPERATION

1. On delay, Interval modes :

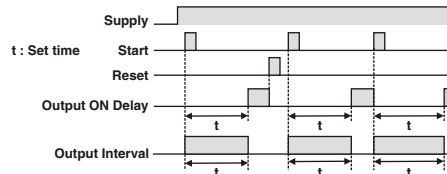

2. Cyclic ON first, Cyclic OFF first modes :

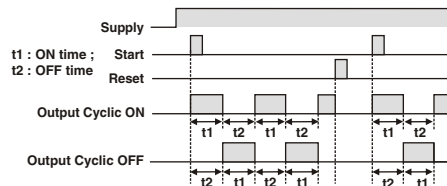

Typical application of Continuous start and reset in On delay mode :

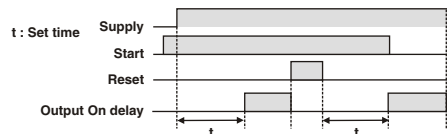

Typical application of Gate start

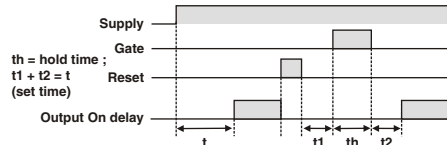

(Specifications are subject to change, since development is a continuous process)

Selec Controls Pvt. Ltd.

Tel. No. : +91-22-40394200 / 40394202
 Fax No. : +91-22-28471733 | Toll free : 1800 227 353
 Website: www.selec.com | Email : sales@selec.com