



Figure 1.1(Product Image)

FEATURES

- PLC with built-in HMI.
- 2 Line x 8 character LCD display.
- RS485 based communication with MODBUS RTU protocol.

SPECIFICATIONS

Display	2 x 8 LCD(Backlight-yellow-Green, Test Black)	
No. of Keys	5(4- User Configuration)	
Supply Voltage	DIGIX-1-230V-CE	DIGIX-1-0-0-24V-CE
	230V AC(90V - 270V AC)	24V DC (18V to 30V DC)
Sensor Supply (SS)	10V, 50mA	NA
Dimensions	70x90x66.4mm	

FUNCTIONAL SPECIFICATIONS (CPU)

Programming Language	Windows based user friendly SELPRO software for ladder logic programming and HMI configuration
Memory	Program Memory : 112KB
	Data Memory : 16KB
	EEPROM Memory : 2KB
	VAR_INOUT & VAR_OUTPUT TYPE Variable :- Max 120 bytes retention
Scan Time	Typical 2ms
Functional Blocks	Time ON delay, Timeer OFF Delay, Pulse Timer, Special Timer, Up/Down Counter etc.
Memory Retention	10 Years

DIGITAL INPUTS

*1= 90° Phase shift signals

Number of Digital Inputs		8(Including 2 Fast Input)				
Operating Modes (User Configuration)		Unidirectional / Bidirectional / Quadrature / Dual Unidirectional / None				
Channel	DI	MODE				
		UNI	BI	QUAD	DUAL UNI	NONE
FC0	DI0	Rate Totalizer	Rate Totalizer	1st Input*1	Rate Totalizer	Digital Input
	DI1	Digital Input	Direction	2st Input*1	Totalizer	Digital Input

Operating Range	5~30V DC	
Input Current	3mA @ 10V	
Action Level	Level 1 → Level0	<3V DC
	Level 0 → Level 1	≥5V DC
Response Level	Digital Input Mode	Typical 2ms (based on ladder scan time)
	Fast Input mode	100 μsec
Input Impedance	7.5 kΩ	
Debounce Time	0 ~ 255 ms (Default=10ms)	
Maximum Counting Frequency (Fast Input)	5KHz	
Prtection Against Polarity Inversion	Yes	

RELAY OUTPUTS

Number Of Relay Outputs	5
Output Type	NO Contact Type
Output Contact Rating	5A @28V DC (Resistive)
	5A @240V AC (Resistive)
Response Time	10ms
Life Expectancy	30000 operation at Full Load
Isolation	No
Existence of common points beteen Relay Channels	COM0 for NO0, NO1
	COM1 for NO2, NO3, NO4

COMMUNICATION DETAILS

Communication Port	RS485 Slave
Communication Protocol	MODBUS RTU
Baud Rate	9600, 19200, 38400, 57600, 115200 (user configuration via software and hardware, Default=19200)

ENVIROMENTAL CONDITION

Operating Temperature	0 to 55°C
Storage Temperature	-20° to 70°C
Humidity(non-condensing)	95%
Mounting	Din Rail Mounted
Weight	Approx. 240gms

SAFETY PRECAUTIONS

This manual is meant for personnel involved in wiring installation, operation and routine maintenance of the equipment.

All safety related conditions, symbols and instructions that appear in this operating manual or on the equipment must be strictly followed to ensure operator and instrument safety. Any misuse may impair the protection provided by the equipment.

CAUTION : Read complete instructions prior to installation and operation of the unit.

CAUTION : Risk of electric shock.

INSTALLATION INSTRUCTIONS

CAUTION

1. This equipment, being built-in-type, normally becomes a part of the main control panel and the terminals do not remain accessible to the user after installation.
2. Conductors must not come in contact with the internal circuitry of the equipment else it may lead to a safety hazard that may endanger life or cause electrical shock to the operator.
3. Circuit breaker or mains switch must be installed between the power source and supply terminals to facilitate power 'ON' or 'OFF' function.
4. The equipment shall not be installed in environmental conditions other than those specified in this manual.
5. Thermal dissipation of equipment is met through ventilation holes provided on housing of equipment. Obstruction of these ventilation holes may lead to a safety hazard.
6. The output terminals shall be loaded strictly as per the values / range specified by the manufacturer.

ELECTRICAL PRECAUTIONS DURING USE

Electrical noise generated by switching of inductive loads can create momentary disruption, erratic display, latch up, data loss or permanent damage to the instrument.

To reduce noise :

Use of Selec make Snubber across load is recommended.
Snubber Part no. : SNUBBER

NOTE : Below mentioned diagram is applicable only for 230V relay outputs.

Typical Connections For Loads :

For load current < 0.5A

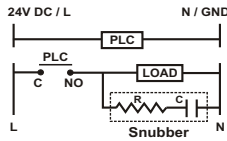

For bigger loads use interposing relay / contactor

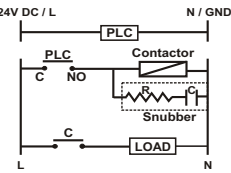

NOTE : Use snubber as shown above to increase life of internal relay.

MECHANICAL INSTALLATION

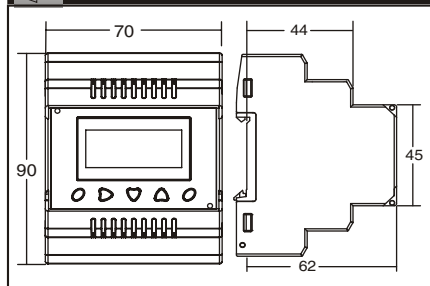

CAUTION

The equipment in its installed state must not come in proximity to any heating sources, caustic vapors, oils, steam or other unwanted process by products.

MAINTENANCE

1. To avoid blockage of ventilation holes, clean the equipment regularly using a soft cloth.
2. Do not use Isopropyl alcohol or any other organic Solvents for cleaning.

WIRING INSTRUCTIONS

CAUTION

1. To prevent risk of electric shock, power supply to the equipment must be kept OFF while wiring.
2. Terminals and electrically charged parts must not be touched when the power is ON.
3. Wiring shall be done strictly according to the terminal layout provided in the operating manual.
4. To eliminate electromagnetic interference use short wire with adequate ratings and twists of equal size.
5. The power supply connection cable must have a cross section of 1sq.mm or greater and insulation capacity of at least 1.5KV.

FUNCTIONAL DETAILS

DIGIX-1-X-X-230V-CE-RoHS is a PLC with built in HMI. The user can configure the product using SELPRO software.

SELPRO has two sections :

1. Ladder logic programming section
2. Selec Machine Interface, used for configuration of HMI.

For details of the software, please refer to the software user manual.

PANEL MOUNTING

Fig. 1

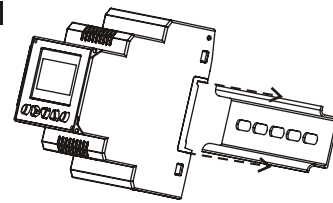
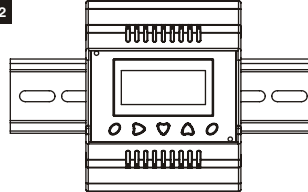
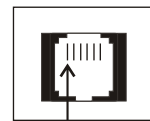

Fig. 2



1. Snap the controller onto the Din Rail as shown in fig. 1 above.
2. When properly mounted, the controller is squarely situated on the Din-rail shown in Fig. 2. above

INTERNAL PINOUT FOR COMMUNICATION RS485 PORT



PIN	DESCRIPTION
1	RS485+ (Slave)
2	---
3	---
4	---
5	---
6	RS485- (Slave)

WIRING DIAGRAM

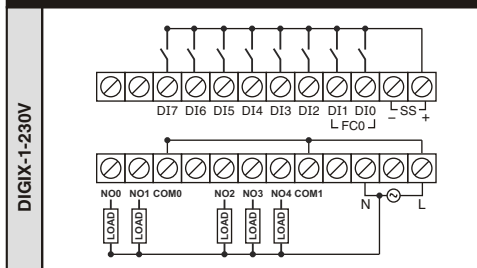

NOTE : When DI's are to be connected to External SMPS, then 0V of Ext. SMPS should be looped with SS- of PLC

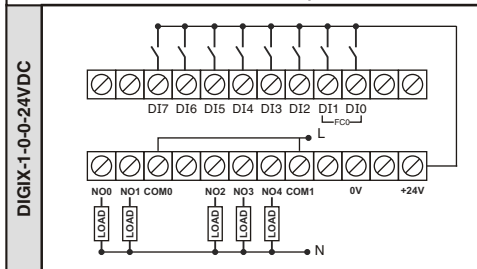

MENU DESCRIPTION

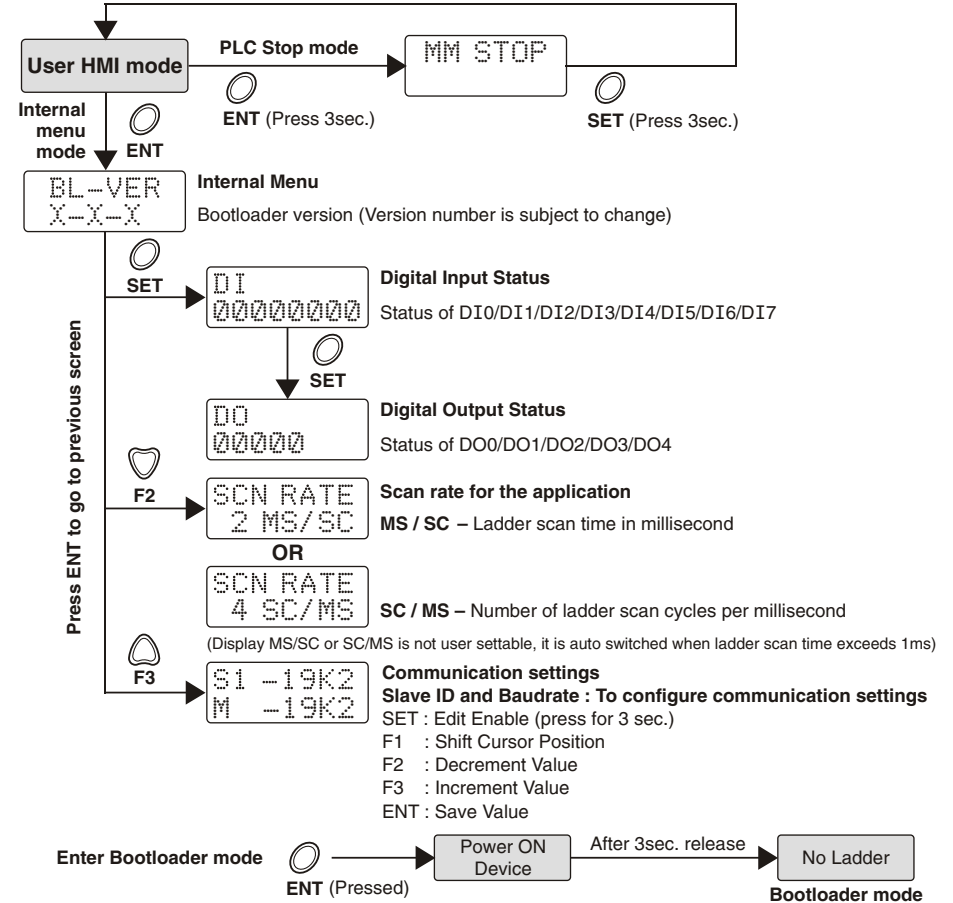

ACCESSORIES (To be ordered separately)

ORDER CODE	DESCRIPTION
AC-USB-RS485-03	USB to RS485 cable (6 pin jack for downloading)
AC-USB-RS485-02*	USB to RS485 cable (2 pin open wire)
ACH-004	RJ25 (6-pin) cable
AC-IOEXP-03	Port Expansion adapter

Note: * Along with ACH-004 & AC-IOEXP-03 for networking

ORDER CODE INFORMATION

	CE	UL LISTED
DIGIX-1-230V-CE	✓	---
DIGIX-1-0-0-24VDC-CE	✓	---

SERVICE DETAILS

This device contains no user serviceable parts and requires special equipment and specialized engineers for repair. Please contact service center for repair on the following numbers :
Tel. No. : + 91-7498077172 ;
Email : service@selec.com

NO WARRANTY ON UNIT DAMAGED DUE TO WRONG POWER SUPPLY.

(Specifications are subject to change, since development is a continuous process.)

Selec Controls Pvt. Ltd., India

Factory Address :
EL-27/1, Electronic Zone, TTC Industrial Area, MIDC, Mahape, Navi Mumbai - 400 710, INDIA.
Tel. No. : +91-22-41 418 419/430 | Fax No. : +91-22-28471733
Toll free : 1800 227 353 (BSNL/MTNL Subscribers only)
Website : www.selec.com | Email : sales@selec.com