

70 x 90 x 66.4mm

FEATURES

> RS485 based communication with MODBUS RTU protocol

SPECIFICATIONS

No. Of LED	16 (RED)
Supply Voltage	24 VDC (±10%)

FUNCTIONAL SPECIFICATIONS (CPU)

Programming Language	Windows based user friendly SELPRO software for ladder logic programming.
Memory	Program Memory : 112 kB
	Data Memory : 16 kB
	EEPROM Memory : 1 kB
	VAR_INOUT & VAROUTPUT TYPE Variables : - Max 120 bytes retention
Scan Time	Typical 2ms
Function Blocks	Timer On delay, Timer Off delay, Pulse Timer, Special Timer, Up/Down Counter etc.
Memory Retention	10 Years

DIGITAL INPUTS

*1 = 90° Phase shift signals

Number of Digital Inputs		8 (Including 2 Fast Input)				
Operating Modes (user configurable)		Unidirectional / Bidirectional / Quadrature / Dual Unidirectional / None				
Channel	DI	MODE				
		UNI	BI	QUAD	DUAL UNI	None
FC0	DI0	Rate Totalizer	Rate Totalizer	1st input*1	Rate Totalizer	Digital Input
	DI1	Digital Input	Direction	2nd input*1	Totalizer	Digital Input
Operating Range		5 ~ 30V DC				
Input current		2 mA @12V				
Action Level	Level 1 ➡ Level 0	<3V DC				
	Level 0 ➡ Level 1	≥5V DC				
Response Time	Digital Input mode	Typical 2ms (based on ladder scan time)				
	Fast Input mode	100µsec				
Input Impedance		7.5 kΩ				
Debounce Time		0 ~ 255 ms (Default = 10 ms)				
Maximum counting Frequency (Fast Input)		5kHz				
Protection against polarity Inversions		Yes				

RELAY OUTPUTS	
Number of Relay Outputs	5
Output Type	NO contact type
Output Current	5A @28VDC (Resistive) 5A @240VAC (Resistive)
Response Time	10ms
Life Expectancy	30000 operation at full load
Isolation	No
Existence of common points between channels	COM0 for NO0, NO1 COM1 for NO2, NO3, NO4

COMMUNICATION		
Communication Port	Jack	RS485 Slave
Communication Protocol	MODBUS RTU	
Baud Rate	9600, 19200, 38400, 57600, 115200 (user configurable via software and hardware) Default = 19200 (Preferred ladder downloading at 19200)	

ENVIRONMENTAL CONDITIONS	
Operating Temperature	0 to 55°C
Storage Temperature	-20 to 70°C
Humidity (non-condensing)	95%
Mounting	Din Rail Mounted
Weight	220 gms

SAFETY PRECAUTIONS

This manual is meant for personnel involved in wiring installation, operation and routine maintenance of the equipment.
All safety related conditions, symbols and instructions that appear in this operating manual or on the equipment must be strictly followed to ensure operator and instrument safety. Any misuse may impair the protection provided by the equipment.

CAUTION : Read complete instructions prior to installation and operation of the unit.

CAUTION : Risk of electric shock.

INSTALLATION INSTRUCTIONS

CAUTION

1. This equipment, being built-in-type, normally becomes a part of the main control panel and the terminals do not remain accessible to the user after installation.
2. Conductors must not come in contact with the internal circuitry of the equipment else it may lead to a safety hazard that may endanger life or cause electrical shock to the operator.
3. Circuit breaker or mains switch must be installed between the power source and supply terminals to facilitate power 'ON' or 'OFF' function.
4. The equipment shall not be installed in environmental conditions other than those specified in this manual.
5. Thermal dissipation of equipment is met through ventilation holes provided on housing of equipment. Obstruction of these ventilation holes may lead to a safety hazard.
6. The output terminals shall be loaded strictly as per the values / range specified by the manufacturer.

ELECTRICAL PRECAUTIONS DURING USE

Electrical noise generated by switching of inductive loads can create momentary disruption, erratic display, latch up, data loss or permanent damage to the instrument.

To reduce noise :

Use of Selec make Snubber across load is recommended.
Snubber Part no. : SNUBBER

NOTE : Below mentioned diagram is applicable only for 230V relay outputs.

Typical Connections For Loads :

For load current < 0.5A

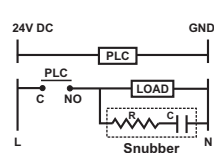

For bigger loads use interposing relay / contactor

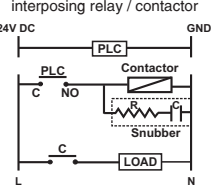

NOTE : Use snubber as shown above to increase life of internal relay.

MECHANICAL INSTALLATION

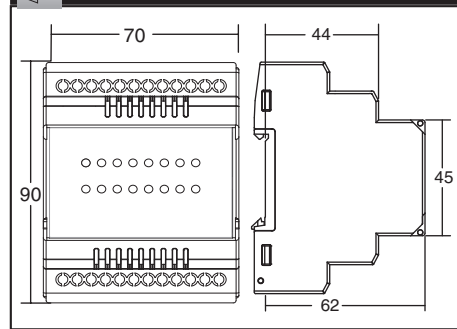

CAUTION

The equipment in its installed state must not come in proximity to any heating sources, caustic vapors, oils, steam or other unwanted process by products.

MAINTENANCE

- To avoid blockage of ventilation holes, clean the equipment regularly using a soft cloth.
- Do not use Isopropyl alcohol or any other organic Solvents for cleaning.

WIRING INSTRUCTIONS

CAUTION

- To prevent risk of electric shock, power supply to the equipment must be kept OFF while wiring.
- Terminals and electrically charged parts must not be touched when the power is ON.
- Wiring shall be done strictly according to the terminal layout provided in the operating manual.
- To eliminate electromagnetic interference use short wire with adequate ratings and twists of equal size.
- The power supply connection cable must have a cross section of 1sq.mm or greater and insulation capacity of at least 1.5KV.

FUNCTIONAL DETAILS

DIGIX-1-0-0-24VDC-B is a PLC built with LED configuration. The user can configure the product using SELPRO software.

SELPRO has two section :

- Ladder logic programming section
- Selec Machine Interface, used for configuration of LED.

For details of the software, please refer to the software user manual.

PANEL MOUNTING

Fig. 1

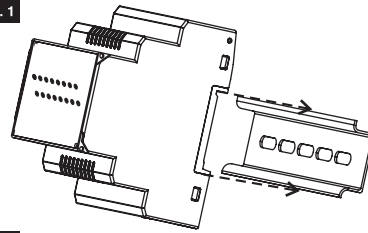
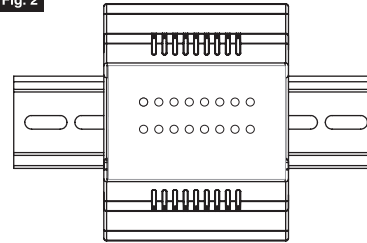
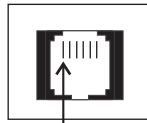

Fig. 2



- Snap the controller onto the Din Rail as shown in fig. 1 above.
- When properly mounted, the controller is squarely situated on the Din-rail shown in Fig. 2. above

INTERNAL PINOUT FOR COMMUNICATION RS485 PORT



PIN 1

PIN	DESCRIPTION
1	RS485+ (Slave)
2	---
3	---
4	---
5	---
6	RS485- (Slave)

WIRING DIAGRAM

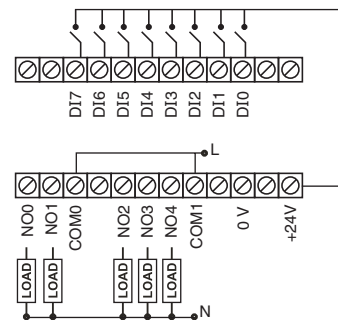

MENU DESCRIPTION

LED WINDOW

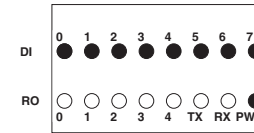
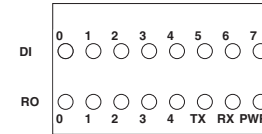

Digital Input Status

Status of DI0/DI1/DI2/DI3/DI4/DI5/DI6/DI7

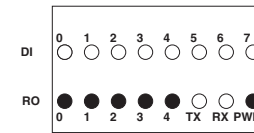

Digital Output Status

Status of DO0/DO1/DO2/DO3/DO4

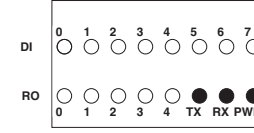

Communication Status

Status of transmit / receive (blinking)

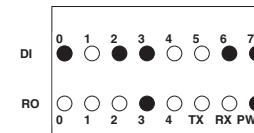

Bootloader mode

Blinking LED indicates BL version 11.3-1 Except than PWR LED

ACCESSORIES (To be ordered separately)

ORDER CODE	DESCRIPTION
AC-USB-RS485-03	USB to RS485 cable (6 pin jack for downloading)
AC-USB-RS485-02 *	USB to RS485 cable (2 pin open wire)
ACH-004	RJ25 (6-pin) cable
AC-IOEXP-03	Port Expansion adapter

Note: * Along with ACH-004 & AC-IOEXP-03 for networking

? SERVICE DETAILS

This device contains no user serviceable parts and requires special equipment and specialized engineers for repair.

Please contact service center for repair on the following numbers :

Tel. No. : + 91-7498077172 ;

Email : service@selec.com

NO WARRANTY ON UNIT DAMAGED DUE TO WRONG POWER SUPPLY.

(Specifications are subject to change, since development is a continuous process.)

Selec Controls Pvt. Ltd., India

Factory Address :

EL-27/1, Electronic Zone, TTC Industrial Area, MIDC, Mahape, Navi Mumbai - 400 710, INDIA.

Tel. No. : +91-22-41 418 419/430 | Fax No. : +91-22-28471733

Toll free : 1800 227 353 (BSNL/MTNL Subscribers only)

Website : www.selec.com | Email : sales@selec.com